















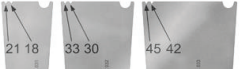



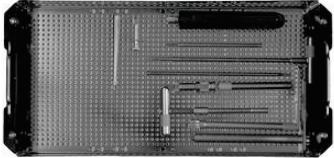

L01.621.004

USS-II Ilium Sacral Instrumentarium, zur Verwendung mit USS-II Polyaxial in Vario Case

Box01/01



Pos.	Mat.Nr	Description		Qty	Unit	Location
Box01/01		Tray 01				
1	03.607.000	Fräser für USS-II Polyaxial		1	ST	B01T01
2	03.607.001	Zwölfkant-Schraubenzieher Ø 3.0 mm, mit T-Griff		1	ST	B01T01
3	03.607.002	Schraubenziehereinsatz für USS-II-Polyaxial Spongiosaschrauben mit dualern Kern, Länge ab 70 mm		1	ST	B01T01
4	03.607.003	USS-II-Polyaxial Haltehülse, zu Nr. 03.607.001		1	ST	B01T01
5	03.607.005	USS-II-Polyaxial Schraubenhalter		2	ST	B01T01
6	03.621.011	Klemmenhalter		2	ST	B01T01
7	03.621.012	Steckschlüssel, durchbohrt, mit geradem Griff für USS-II-Mutter		1	ST	B01T01
8	03.621.031	Schablone für Ilium-Verbinder, kurz		1	ST	B01T01
9	03.621.032	Schablone für Ilium-Verbinder, mittel		1	ST	B01T01
10	03.621.033	Schablone für Ilium-Verbinder, lang		1	ST	B01T01
11	319.011	Tiefenmessgerät für Pedikelschrauben, Messbereich bis 110 mm		1	ST	B01T01
12	388.143	Steckschlüssel Ø 5.0 mm, mit T-Griff		1	ST	B01T01
13	388.584	Steckschlüssel für Zwölfkantmutter, mit L-Griff		1	ST	B01T01
14	388.615	Widerlager für Stabeindrückzangen		1	ST	B01T01
15	388.622	Handgriff für USS-Haken- und Schraubenhalter Nr. 388.612		1	ST	B01T01
16	68.621.030	Vario Case™, Grösse 1/1, Ilium-Fixation, für USS-II Ilium Sacral Instrumentarium		1	ST	B01T01

L01.621.004 USS-II Ilio Sacral Instrumentarium, zur Verwendung mit USS-II Polyaxial in Vario Case

17	689.507	Stahldeckel, Grösse 1/1, für Vario Case™		1	ST	B01T01	
Box01/01 Tray 02							
18	04.300.001	T-Verbinder, offen, für Stäbe Ø 6.0 mm, Titanlegierung (TAN)		8	ST	B01T02	
19	04.607.265	USS-II-Polyaxial Spongiaschraube Ø 7.0 mm mit dualem Kern, Länge 120 mm, Titanlegierung (TAN), türkis		2	ST	B01T02	
20	04.607.269	USS-II-Polyaxial Spongiaschraube Ø 7.0 mm mit dualem Kern, Länge 140 mm, Titanlegierung (TAN), türkis		2	ST	B01T02	
21	04.621.112	Ilium-Verbinder, neutral, fixe Länge 12 mm		2	ST	B01T02	
22	04.621.115	Ilium-Verbinder, neutral, fixe Länge 15 mm		2	ST	B01T02	
23	04.621.118	Ilium-Verbinder, neutral, fixe Länge 18 mm		2	ST	B01T02	
24	04.621.121	Ilium-Verbinder, neutral, fixe Länge 21 mm		2	ST	B01T02	
25	04.621.124	Ilium-Verbinder, neutral, fixe Länge 24 mm		2	ST	B01T02	
26	04.621.127	Ilium-Verbinder, neutral, fixe Länge 27 mm		2	ST	B01T02	
27	04.621.130	Ilium-Verbinder, neutral, fixe Länge 30 mm		2	ST	B01T02	
28	04.621.133	Ilium-Verbinder, neutral, fixe Länge 33 mm		1	ST	B01T02	
29	04.621.136	Ilium-Verbinder, neutral, fixe Länge 36 mm		1	ST	B01T02	
30	04.621.139	Ilium-Verbinder, neutral, fixe Länge 39 mm		1	ST	B01T02	
31	04.621.142	Ilium-Verbinder, neutral, fixe Länge 42 mm		1	ST	B01T02	
32	04.621.145	Ilium-Verbinder, neutral, fixe Länge 45 mm		1	ST	B01T02	
33	04.621.171	Ilium-Verbinder, teleskopisch, neutral, Länge 17 bis 27 mm			2	ST	B01T02
34	04.621.190	Spannbacke für Ilium-Verbinder und S2-Verbinder, für alle Grössen			6	ST	B01T02
35	04.621.260	S2-Verbinder, links, für Stäbe Ø 6.0 mm		1	ST	B01T02	
36	04.621.261	S2-Verbinder, rechts, für Stäbe Ø 6.0 mm		1	ST	B01T02	
37	04.621.262	S2-Verbinder für Stabende, für Stäbe Ø 6.0 mm		1	ST	B01T02	
38	04.621.270	Klemme für teleskopischen Ilium-Verbinder		4	ST	B01T02	

L01.621.004

USS-II Ilio Sacral Instrumentarium, zur Verwendung mit USS-II Polyaxial in Vario Case

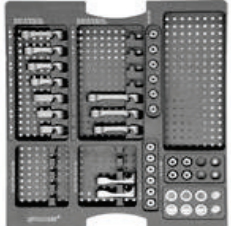
39	04.621.275	Klemme für Ilium-Verbinder, für fixe Länge		6	ST	B01T02
40	499.294	USS-II-Mutter, Titanlegierung (TAN), grün		8	ST	B01T02
41	68.621.020	Modul für USS-II Ilio Sacral Implantate		1	ST	B01T02

Box01/01

Tray 03

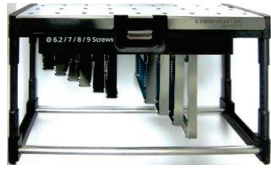
42	04.607.254	USS-II-Polyaxial Spongiosaschraube Ø 7.0 mm mit dualem Kern, Länge 40 mm, Titanlegierung (TAN), türkis		2	ST	B01T03
43	04.607.255	USS-II-Polyaxial Spongiosaschraube Ø 7.0 mm mit dualem Kern, Länge 45 mm, Titanlegierung (TAN), türkis		2	ST	B01T03
44	04.607.256	USS-II-Polyaxial Spongiosaschraube Ø 7.0 mm mit dualem Kern, Länge 50 mm, Titanlegierung (TAN), türkis		2	ST	B01T03
45	04.607.257	USS-II-Polyaxial Spongiosaschraube Ø 7.0 mm mit dualem Kern, Länge 55 mm, Titanlegierung (TAN), türkis		2	ST	B01T03
46	04.607.258	USS-II-Polyaxial Spongiosaschraube Ø 7.0 mm mit dualem Kern, Länge 60 mm, Titanlegierung (TAN), türkis		2	ST	B01T03
47	04.607.259	USS-II-Polyaxial Spongiosaschraube Ø 7.0 mm mit dualem Kern, Länge 65 mm, Titanlegierung (TAN), türkis		2	ST	B01T03
48	04.607.260	USS-II-Polyaxial Spongiosaschraube Ø 7.0 mm mit dualem Kern, Länge 70 mm, Titanlegierung (TAN), türkis		2	ST	B01T03
49	04.607.261	USS-II-Polyaxial Spongiosaschraube Ø 7.0 mm mit dualem Kern, Länge 80 mm, Titanlegierung (TAN), türkis		2	ST	B01T03
50	04.607.262	USS-II-Polyaxial Spongiosaschraube Ø 7.0 mm mit dualem Kern, Länge 90 mm, Titanlegierung (TAN), türkis		2	ST	B01T03
51	04.607.263	USS-II-Polyaxial Spongiosaschraube Ø 7.0 mm mit dualem Kern, Länge 100 mm, Titanlegierung (TAN), türkis		2	ST	B01T03
52	68.621.040	Modul für Spongiosaschrauben		1	ST	B01T03

Depuy Synthes GmbH
OrthoKit® Rental Service

Im Brunnenfeld 8
D-79224 Umkirch

www.depuythes.com



L01.621.004

USS-II Ilio Sacral Instrumentarium, zur Verwendung mit USS-II Polyaxial in Vario Case

B01T01

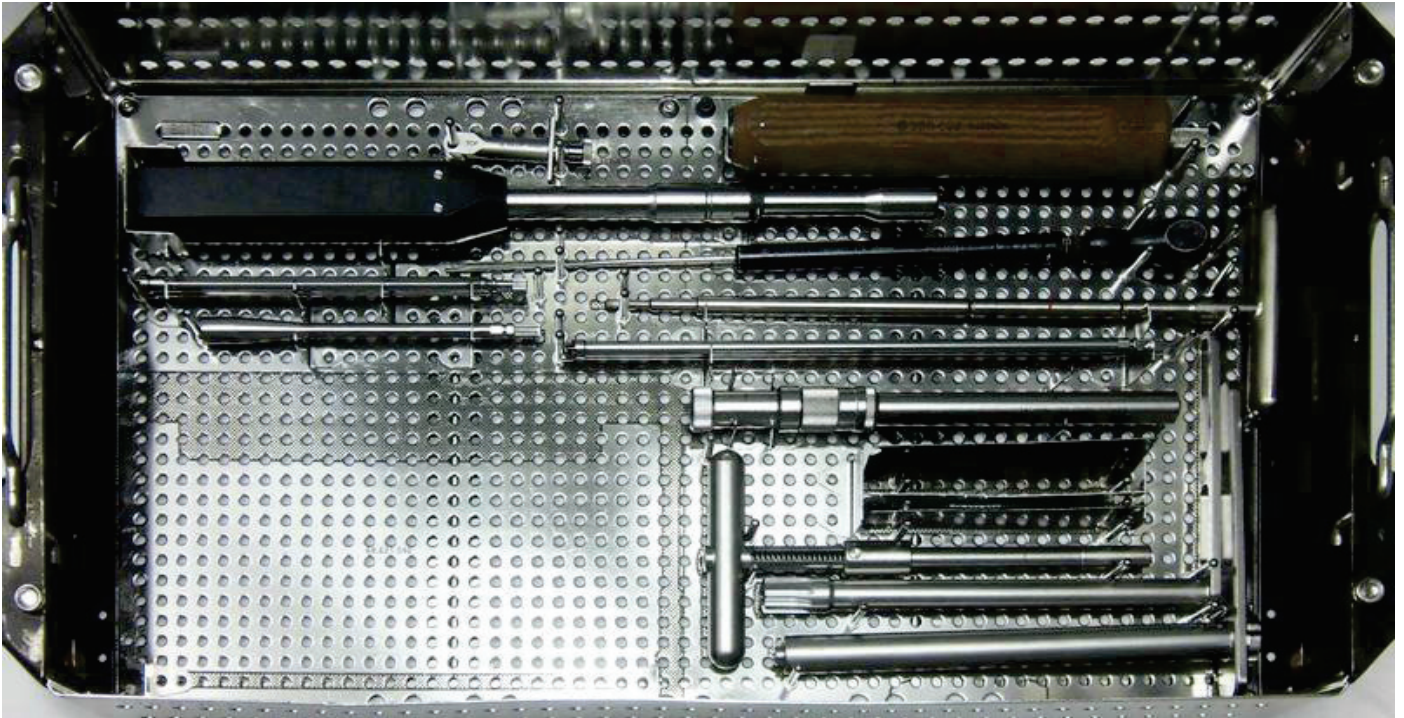

B01T02

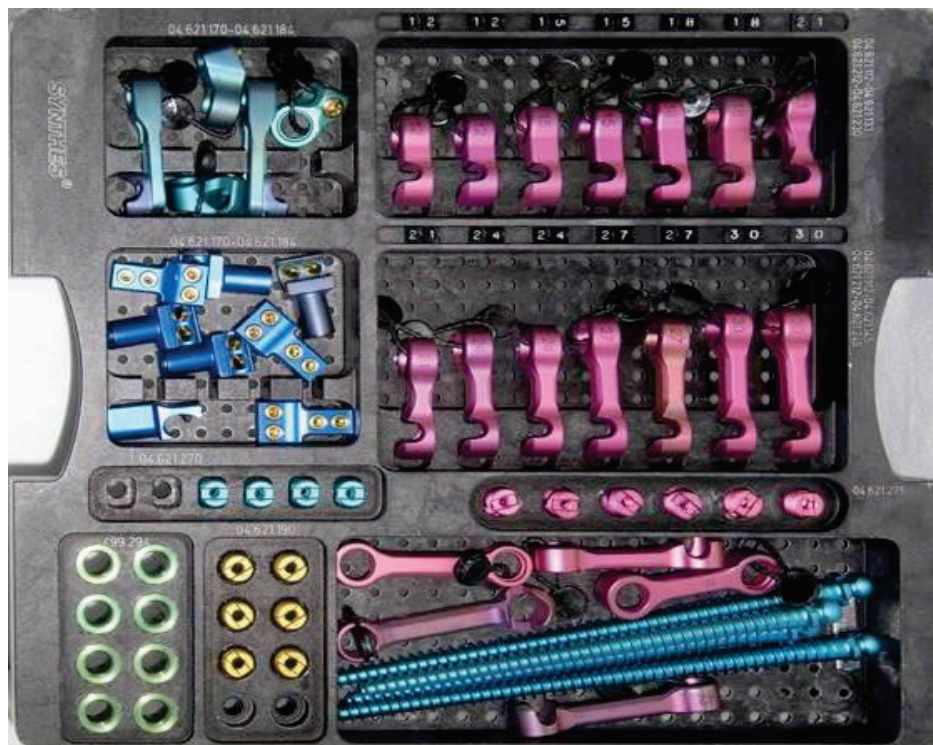

Depuy Synthes GmbH
OrthoKit® Rental Service

Im Brunnenfeld 8
D-79224 Umkirch

www.depuySynthes.com



L01.621.004

**USS-II Ilio Sacral Instrumentarium, zur Verwendung mit USS-II
Polyaxial in Vario Case**

B01T03



*****End of document*****