







Depuy Synthes GmbH  
OrthoKit® Rental Service

Im Brunnenfeld 8  
D-79224 Umkirch

Tel. +49 800 201 20 70  
Fax +49 7665 503 290  
www.depuysynthes.com

**L01.211.024****VA-LCP MTP-Fusionsplatten 2.4/2.7 Instrumente und Implantate****Box01/01**



Pos.	Mat.Nr	Description		Qty	Unit	Location
<b>Box01/01</b>						
<b>Module 01</b>						
1	03.211.400	Kompressionszange zur Verwendung mit Kompressionsdraht		1	ST	B01M01
2	03.211.410.01	Kompressionsdraht Ø 1.6 mm, Länge 150 mm, Gewindelänge 10 mm		4	ST	B01M01
3	03.211.415.01	Kompressionsdraht Ø 1.6 mm, Länge 150 mm, Gewindelänge 15 mm		4	ST	B01M01
4	03.211.420.01	Kompressionsdraht Ø 1.6 mm, Länge 150 mm, Gewindelänge 20 mm		4	ST	B01M01
5	03.211.425.01	Kompressionsdraht Ø 1.6 mm, Länge 150 mm, Gewindelänge 25 mm		4	ST	B01M01
6	03.211.430.01	Kompressionsdraht Ø 1.6 mm, Länge 150 mm, Gewindelänge 30 mm		4	ST	B01M01
7	03.211.435.01	Kompressionsdraht Ø 1.6 mm, Länge 150 mm, Gewindelänge 35 mm		4	ST	B01M01
8	03.211.440.01	Kompressionsdraht Ø 1.6 mm, Länge 150 mm, Gewindelänge 40 mm		4	ST	B01M01
9	292.560.01	Kirschnerdraht Ø 1.6 mm mit Doppelspitze, Länge 150 mm, Stahl			5	ST
10	68.211.001	Modularer Einsatz für Kompressionssystem 2.4/2.7 mm, Grösse 1/4, ohne Inhalt, 2.4/2.7 mm, Grösse 1/4, ohne Inhalt, Vario Case™ System		1	ST	B01M01
11	68.211.007	Modularer Einsatz für Kompressionsdrähte für Einsatz 68.211.001		1	ST	B01M01
12	68.000.102	Deckel zu 68.211.001		1	ST	B01M01
<b>Box01/01</b>						
<b>Module 02</b>						
13	03.211.016	Durchbohrter Distal-Fräser Ø 16 mm		1	ST	B01M02
14	03.211.018	Durchbohrter Distal-Fräser Ø 18 mm		1	ST	B01M02
15	03.211.020	Durchbohrter Distal-Fräser Ø 20 mm		1	ST	B01M02

Depuy Synthes GmbH  
OrthoKit® Rental Service

Im Brunnenfeld 8  
D-79224 Umkirch

Tel. +49 800 201 20 70  
Fax +49 7665 503 290  
www.depuysynthes.com

**L01.211.024****VA-LCP MTP-Fusionsplatten 2.4/2.7 Instrumente und Implantate**

16	03.211.022	Durchbohrter Distal-Fräser Ø 22 mm		1	ST	B01M02
17	03.211.024	Durchbohrter Distal-Fräser Ø 24 mm		1	ST	B01M02
18	03.211.116	Durchbohrter Proximal-Fräser Ø 16 mm		1	ST	B01M02
19	03.211.118	Durchbohrter Proximal-Fräser Ø 18 mm		1	ST	B01M02
20	03.211.120	Durchbohrter Proximal-Fräser Ø 20 mm		1	ST	B01M02
21	03.211.122	Durchbohrter Proximal-Fräser Ø 22 mm		1	ST	B01M02
22	03.211.124	Durchbohrter Proximal-Fräser Ø 24 mm		1	ST	B01M02



23	68.211.002	Modularer Einsatz für Distal- und Proximal-Fräser 2.4/2.7, Grösse 1/4, ohne Inhalt, Vario Case™ System		1	ST	B01M02
----	------------	--	--	---	----	--------



24	68.000.102	Deckel zu 68.211.002		1	ST	B01M02
----	------------	----------------------	--	---	----	--------

Pos.	Mat.Nr	Description	Qty	Unit	Location
------	--------	-------------	-----	------	----------

**Box01/01 Module 03**

25	03.110.002	Drehmomentbegrenzer, 1.2 Nm, mit AO/ASIF-Schnellkupplung		1		B01M03
----	------------	--	--	---	--	--------

26	03.110.005	Handstück für Drehmomentbegrenzer 0.4/0.8/1.2 Nm		1		B01M03
----	------------	--	--	---	--	--------

27	03.111.005	Tiefenmessgerät für Schrauben Ø 2.0 bis 2.7 mm, Messbereich bis 40 mm		1		B01M03
----	------------	---	--	---	--	--------

28	03.111.038	Griff mit Schnellkupplung		1		B01M03
----	------------	---------------------------	--	---	--	--------

29	03.211.001	Haltestift für VA-Verriegelungsplatten 2.4/2.7		1		B01M03
----	------------	--	--	---	--	--------

30	03.211.003	VA-LCP Bohrbüchse 2.7, konisch, für Spiralbohrer Ø 2.0 mm		1		B01M03
----	------------	---	--	---	--	--------

Depuy Synthes GmbH  
OrthoKit® Rental Service







Im Brunnenfeld 8  
D-79224 Umkirch

Tel. +49 800 201 20 70  
Fax +49 7665 503 290  
www.depuysynthes.com



## L01.211.024

## VA-LCP MTP-Fusionsplatten 2.4/2.7 Instrumente und Implantate

31	03.211.004	VA-LCP Bohrbüchse 2.7, koaxial, für Spiralbohrer Ø 2.0 mm		1		B01M03
32	310.260	Spiralbohrer Ø 2.7 mm, Länge 100/75 mm, 2-lippig, für Schnellkupplung		1		B01M03
33	310.534	Spiralbohrer Ø 2.0 mm, mit Markierung, Länge 110/85 mm, 2-lippig, für Schnellkupplung		1		B01M03
34	314.467	Schraubenziehereinsatz, Stardrive®, T8, selbsthaltend		1		B01M03
35	323.260	Universalbohrbüchse 2.7		1		B01M03
36	68.211.003	Modularer Einsatz für VA-Instrumente 2.4/2.7 mm, Grösse 1/4, ohne Inhalt, Vario Case™ System		1	ST	B01M03
37	68.000.102	Deckel zu 68.211.003		1	ST	B01M03

Pos.	Mat.Nr	Description	Qty	Unit	Location
------	--------	-------------	-----	------	----------

Box01/01

**Module 04**

38	03.211.005	Biegezange für VA-Verriegelungsplatten		2	ST	B01M04
39	68.211.005	Modularer Einsatz für Biegezange für VA-Verriegelungsplatten 2.4/2.7 mm, VA-Verriegelungsplatten 2.4/2.7 mm, Grösse 1/4, ohne Inhalt, Vario Case™ System		1	ST	B01M04

Depuy Synthes GmbH  
OrthoKit® Rental Service

Im Brunnenfeld 8  
D-79224 Umkirch

Tel. +49 800 201 20 70  
Fax +49 7665 503 290  
www.depuysynthes.com



## L01.211.024 VA-LCP MTP-Fusionsplatten 2.4/2.7 Instrumente und Implantate

40 68.000.102 Deckel zu 68.211.005 1 ST B01M04



Pos.	Mat.Nr	Description	Qty	Unit	Location
<b>Box01/01 Module 05</b>					
41	04.211.010	VA-Verriegelungsschraube Stardrive® Ø 2.7 mm (Kopf 2.4), selbstschneidend, Länge 10 mm, Titanlegierung (TAN)	4	ST	B01M05
42	04.211.012	VA-Verriegelungsschraube Stardrive® Ø 2.7 mm (Kopf 2.4), selbstschneidend, Länge 12 mm, Titanlegierung (TAN)	4	ST	B01M05
43	04.211.014	VA-Verriegelungsschraube Stardrive® Ø 2.7 mm (Kopf 2.4), selbstschneidend, Länge 14 mm, Titanlegierung (TAN)	4	ST	B01M05
44	04.211.016	VA-Verriegelungsschraube Stardrive® Ø 2.7 mm (Kopf 2.4), selbstschneidend, Länge 16 mm, Titanlegierung (TAN)	4	ST	B01M05
45	04.211.018	VA-Verriegelungsschraube Stardrive® Ø 2.7 mm (Kopf 2.4), selbstschneidend, Länge 18 mm, Titanlegierung (TAN)	4	ST	B01M05
46	04.211.020	VA-Verriegelungsschraube Stardrive® Ø 2.7 mm (Kopf 2.4), selbstschneidend, Länge 20 mm, Titanlegierung (TAN)	4	ST	B01M05
47	04.211.022	VA-Verriegelungsschraube Stardrive® Ø 2.7 mm (Kopf 2.4), selbstschneidend, Länge 22 mm, Titanlegierung (TAN)	4	ST	B01M05
48	04.211.024	VA-Verriegelungsschraube Stardrive® Ø 2.7 mm (Kopf 2.4), selbstschneidend, Länge 24 mm, Titanlegierung (TAN)	4	ST	B01M05
49	04.211.026	VA-Verriegelungsschraube Stardrive® Ø 2.7 mm (Kopf 2.4), selbstschneidend, Länge 26 mm, Titanlegierung (TAN)	4	ST	B01M05
50	04.211.028	VA-Verriegelungsschraube Stardrive® Ø 2.7 mm (Kopf 2.4), selbstschneidend, Länge 28 mm, Titanlegierung (TAN)	4	ST	B01M05
51	04.211.030	VA-Verriegelungsschraube Stardrive® Ø 2.7 mm (Kopf 2.4), selbstschneidend, Länge 30 mm, Titanlegierung (TAN)	4	ST	B01M05
52	04.211.032	VA-Verriegelungsschraube Stardrive® Ø 2.7 mm (Kopf 2.4), selbstschneidend, Länge 32 mm, Titanlegierung (TAN)	4	ST	B01M05
53	04.211.034	VA-Verriegelungsschraube Stardrive® Ø 2.7 mm (Kopf 2.4), selbstschneidend, Länge 34 mm, Titanlegierung (TAN)	4	ST	B01M05
54	04.211.036	VA-Verriegelungsschraube Stardrive® Ø 2.7 mm (Kopf 2.4), selbstschneidend, Länge 36 mm, Titanlegierung (TAN)	4	ST	B01M05
55	04.211.038	VA-Verriegelungsschraube Stardrive® Ø 2.7 mm (Kopf 2.4), selbstschneidend, Länge 38 mm, Titanlegierung (TAN)	4	ST	B01M05
56	04.211.040	VA-Verriegelungsschraube Stardrive® Ø 2.7 mm (Kopf 2.4), selbstschneidend, Länge 40 mm, Titanlegierung (TAN)	4	ST	B01M05
57	402.870	Kortikalisschraube Stardrive® Ø 2.7 mm, selbstschneidend, Länge 10 mm, Titanlegierung (TAN)	3	ST	B01M05
58	402.872	Kortikalisschraube Stardrive® Ø 2.7 mm, selbstschneidend, Länge 12 mm, Titanlegierung (TAN)	3	ST	B01M05
59	402.874	Kortikalisschraube Stardrive® Ø 2.7 mm, selbstschneidend, Länge 14 mm, Titanlegierung (TAN)	3	ST	B01M05







Depuy Synthes GmbH  
OrthoKit® Rental Service

Im Brunnenfeld 8  
D-79224 Umkirch

Tel. +49 800 201 20 70  
Fax +49 7665 503 290  
www.depuysynthes.com



## L01.211.024 VA-LCP MTP-Fusionsplatten 2.4/2.7 Instrumente und Implantate

60	402.876	Kortikalisschraube Stardrive® Ø 2.7 mm, selbstschneidend, Länge 16 mm, Titanlegierung (TAN)		3	ST	B01M05
61	402.878	Kortikalisschraube Stardrive® Ø 2.7 mm, selbstschneidend, Länge 18 mm, Titanlegierung (TAN)		3	ST	B01M05
62	402.880	Kortikalisschraube Stardrive® Ø 2.7 mm, selbstschneidend, Länge 20 mm, Titanlegierung (TAN)		3	ST	B01M05
63	402.882	Kortikalisschraube Stardrive® Ø 2.7 mm, selbstschneidend, Länge 22 mm, Titanlegierung (TAN)		3	ST	B01M05
64	402.884	Kortikalisschraube Stardrive® Ø 2.7 mm, selbstschneidend, Länge 24 mm, Titanlegierung (TAN)		3	ST	B01M05
65	402.886	Kortikalisschraube Stardrive® Ø 2.7 mm, selbstschneidend, Länge 26 mm, Titanlegierung (TAN)		3	ST	B01M05
66	402.888	Kortikalisschraube Stardrive® Ø 2.7 mm, selbstschneidend, Länge 28 mm, Titanlegierung (TAN)		3	ST	B01M05
67	402.890	Kortikalisschraube Stardrive® Ø 2.7 mm, selbstschneidend, Länge 30 mm, Titanlegierung (TAN)		3	ST	B01M05
68	402.892	Kortikalisschraube Stardrive® Ø 2.7 mm, selbstschneidend, Länge 32 mm, Titanlegierung (TAN)		3	ST	B01M05
69	402.894	Kortikalisschraube Stardrive® Ø 2.7 mm, selbstschneidend, Länge 34 mm, Titanlegierung (TAN)		3	ST	B01M05
70	402.896	Kortikalisschraube Stardrive® Ø 2.7 mm, selbstschneidend, Länge 36 mm, Titanlegierung (TAN)		3	ST	B01M05
71	402.898	Kortikalisschraube Stardrive® Ø 2.7 mm, selbstschneidend, Länge 38 mm, Titanlegierung (TAN)		3	ST	B01M05
72	402.900	Kortikalisschraube Stardrive® Ø 2.7 mm, selbstschneidend, Länge 40 mm, Titanlegierung (TAN)		3	ST	B01M05
73	68.000.105	Schraubenrechen, Grösse 1/4, Höhe 56 mm		1	ST	B01M05
74	68.211.011	Schraubenrechenmodul, Grösse 1/3, für Schrauben Ø 2.7 mm (bis 40 mm), für Rahmen, Grösse 1/4		2	ST	B01M05
75	68.000.120	Deckel zu 68.000.105		1	ST	B01M05

Depuy Synthes GmbH  
OrthoKit® Rental Service

Im Brunnenfeld 8  
D-79224 Umkirch

Tel. +49 800 201 20 70  
Fax +49 7665 503 290  
www.depuysynthes.com



## L01.211.024 VA-LCP MTP-Fusionsplatten 2.4/2.7 Instrumente und Implantate

Pos.	Mat.Nr	Description	Qty	Unit	Location
<b>Box01/01 Module 06</b>					
76	04.211.230	1. MTP-Fusionsplatte 2.4/2.7, VA-Verriegelung, klein, Länge 42 mm, neutral, rechts, Titanlegierung (TAN)	1	ST	B01M06
77	04.211.231	1. MTP-Fusionsplatte 2.4/2.7, VA-Verriegelung, klein, Länge 42 mm, neutral, links, Titanlegierung (TAN)	1	ST	B01M06
78	04.211.232	1. MTP-Fusionsplatte 2.4/2.7, VA-Verriegelung, klein, Länge 42 mm, 5°, rechts, Titanlegierung (TAN)	1	ST	B01M06
79	04.211.233	1. MTP-Fusionsplatte 2.4/2.7, VA-Verriegelung, klein, Länge 42 mm, 5°, links, Titanlegierung (TAN)	1	ST	B01M06
80	04.211.236	1. MTP-Fusionsplatte 2.4/2.7, VA-Verriegelung, mittel, Länge 52 mm, neutral, rechts, Titanlegierung (TAN)	1	ST	B01M06
81	04.211.237	1. MTP-Fusionsplatte 2.4/2.7, VA-Verriegelung, mittel, Länge 52 mm, neutral, links, Titanlegierung (TAN)	1	ST	B01M06
82	04.211.238	1. MTP-Fusionsplatte 2.4/2.7, VA-Verriegelung, mittel, Länge 52 mm, 5°, rechts, Titanlegierung (TAN)	1	ST	B01M06
83	04.211.239	1. MTP-Fusionsplatte 2.4/2.7, VA-Verriegelung, mittel, Länge 52 mm, 5°, links, Titanlegierung (TAN)	1	ST	B01M06
84	04.211.240	1. MTP-Fusionsplatte 2.4/2.7, VA-Verriegelung, mittel, Länge 52 mm, 10°, rechts, Titanlegierung (TAN)	1	ST	B01M06
85	04.211.241	1. MTP-Fusionsplatte 2.4/2.7, VA-Verriegelung, mittel, Länge 52 mm, 10°, links, Titanlegierung (TAN)	1	ST	B01M06
86	04.211.242	1. MTP-Fusionsplatte 2.4/2.7, VA-Verriegelung, gross, Länge 57 mm, 5°, rechts, Titanlegierung (TAN)	1	ST	B01M06
87	04.211.243	1. MTP-Fusionsplatte 2.4/2.7, VA-Verriegelung, gross, Länge 57 mm, 5°, links, Titanlegierung (TAN)	1	ST	B01M06
88	68.000.103	Schraubenrechen, Grösse 1/4, Höhe 35.5 mm	1	ST	B01M06
89	68.211.024	Implantatmodul für VA MTP-Fusionsplatten 2.4/2.7, Grösse 1/3, für Rahmen, Grösse 1/4	2	ST	B01M06

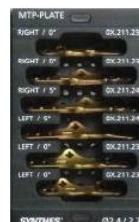
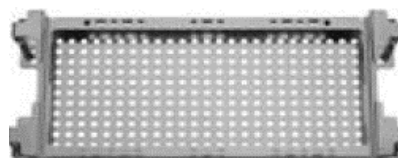

Depuy Synthes GmbH  
OrthoKit® Rental Service

Im Brunnenfeld 8  
D-79224 Umkirch

Tel. +49 800 201 20 70  
Fax +49 7665 503 290  
www.depuysynthes.com



**L01.211.024 VA-LCP MTP-Fusionsplatten 2.4/2.7 Instrumente und Implantate**

90	68.000.120	Deckel zu 68.000.103		1	ST	B01M06
----	------------	----------------------	--	---	----	--------

Pos.	Mat.Nr	Description	Qty	Unit	Location
------	--------	-------------	-----	------	----------

**Box01/01 Tray 01**

91	689.510	Vario Case™, Rahmen, Grösse 1/1, Höhe 88 mm		1	ST	B01T01
----	---------	---	--	---	----	--------

92	689.507	Stahldeckel, Grösse 1/1, für Vario Case™		1	ST	B01T01
----	---------	--	---	---	----	--------





Depuy Synthes GmbH  
OrthoKit® Rental Service

Im Brunnenfeld 8  
D-79224 Umkirch

www.depuyshntes.com



## L01.211.024 VA-LCP MTP-Fusionsplatten 2.4/2.7 Instrumente und Implantate

B01M03

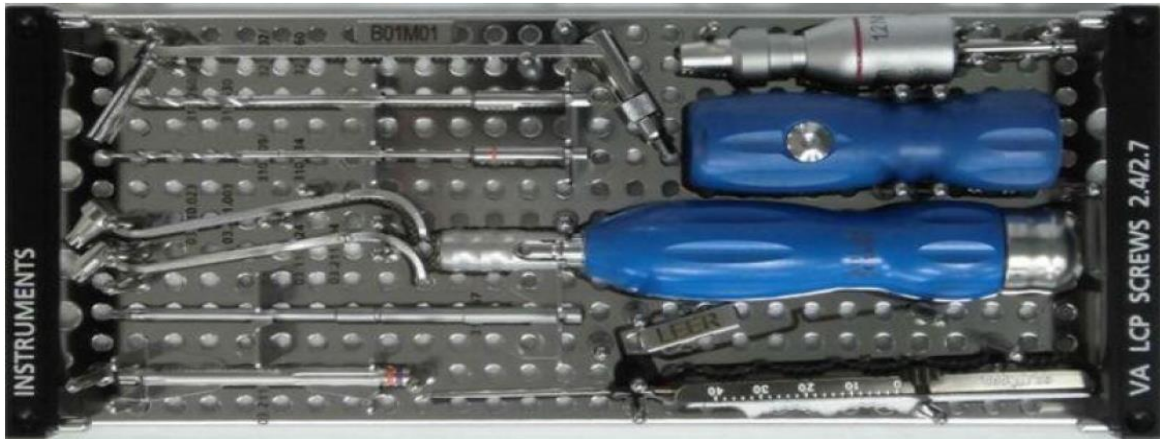

B01M04



Depuy Synthes GmbH  
OrthoKit® Rental Service

Im Brunnenfeld 8  
D-79224 Umkirch

www.depuyshntes.com



## L01.211.024

## VA-LCP MTP-Fusionsplatten 2.4/2.7 Instrumente und Implantate

### B01M05

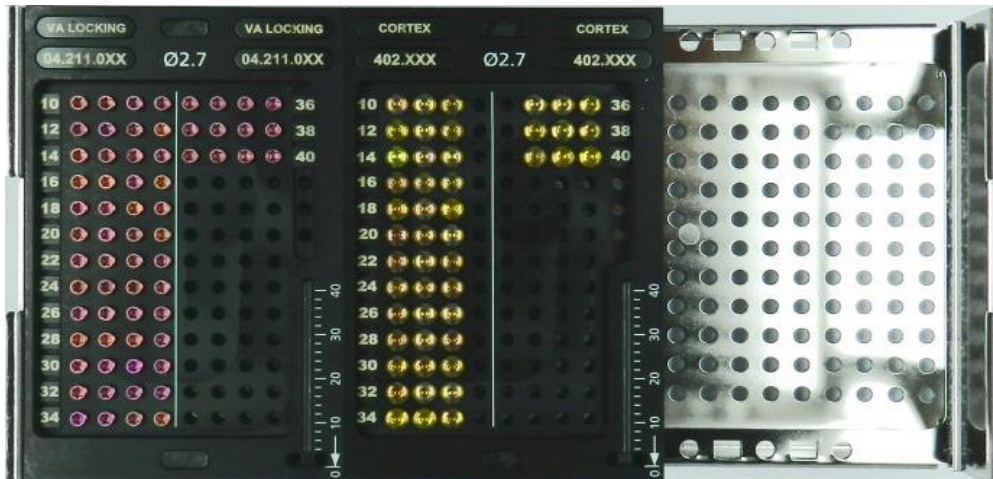

### B01M06



\*\*\*End of document\*\*\*