

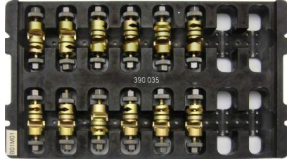









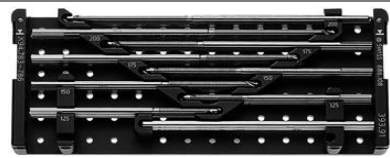

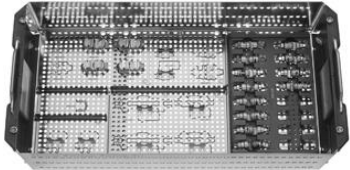
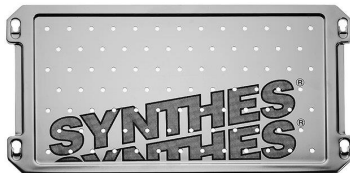







L01.302.000 Mittlerer Fixateur externe in Vario Case™

Box01/01

Pos.	Mat.Nr	Description		Qty	Unit	Location
Box01/01		Module 01				
1	390.035	Backe, mittel, aufsteckbar, selbsthaltend		12	ST	B01M01
2	68.301.011	Modul für Backen, für Grossen Fixateur externe, zu Nr. 68.301.000		1	ST	B01M01
Box01/01		Module 02				
3	494.771	Seldrill™ Schanzsche Schraube Ø 4.0/3.0 mm, Länge 80/20 mm, Reintitan		4	ST	B01M02
4	494.776	Seldrill™ Schanzsche Schraube Ø 4.0 mm, Länge 100/30 mm, Reintitan		4	ST	B01M02
5	494.777	Seldrill™ Schanzsche Schraube Ø 4.0 mm, Länge 125/40 mm, Reintitan		4	ST	B01M02
6	494.783	Seldrill™ Schanzsche Schraube Ø 5.0 mm, Länge 125/40 mm, Reintitan		4	ST	B01M02
7	494.785	Seldrill™ Schanzsche Schraube Ø 5.0 mm, Länge 175/60 mm, Reintitan		4	ST	B01M02
8	686.153	Deckel zu Modul 686.151		1	ST	B01M02
9	686.151	Einsatz für Schanzsche Schrauben Ø 4.0 bis 5.0 mm, mit Deckel, ohne Inhalt		1	ST	B01M02
Box01/01		Tray 01				
10	390.031	Kombinationsbacke, mittel, aufsteckbar, selbsthaltend		4	ST	B01T01
11	390.037	Kombinationsbacke 8.0/11.0, aufsteckbar, selbsthaltend		2	ST	B01T01
12	68.302.000	Vario Case™ für Mittleren Fixateur externe, ohne Deckel, ohne Inhalt		1	ST	B01T01

L01.302.000 Mittlerer Fixateur externe in Vario Case™

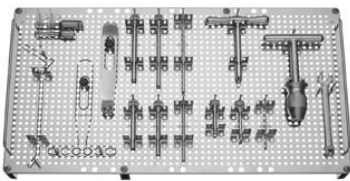

13	689.507	Stahldeckel, Grösse 1/1, für Vario Case™		1	ST	B01T01
Box01/01		Tray 02				
14	321.158	Ringgabelschlüssel Ø 8.0 mm		1	ST	B01T02
15	388.135	Sechskantschlüssel Ø 3.5 mm mit T-Griff		1	ST	B01T02
16	392.955	Bohrbüchse 4.0/2.5		1	ST	B01T02
17	393.101	Adapter für Seldrill™ Schanzsche Schraube Ø 4.0 mm		1	ST	B01T02
18	393.103	Adapter für Seldrill™ Schanzsche Schraube Ø 5.0 mm		1	ST	B01T02
19	393.105	Universalbohrfutter, klein, mit T-Griff		1	ST	B01T02
20	394.181	Trokar Ø 3.5 mm, kurz		1	ST	B01T02
21	394.182	Trokar Ø 3.5 mm, lang		1	ST	B01T02
22	394.183	Trokar Ø 2.5 mm		1	ST	B01T02
23	395.911	Handgriff für Bohrbüchse		1	ST	B01T02
24	395.912	Bohrbüchse 5.0/3.5, kurz		1	ST	B01T02
25	395.913	Bohrbüchse 5.0/3.5, lang		1	ST	B01T02
26	395.921	Bohrbüchse 6.0/5.0, kurz, mit Gewinde		1	ST	B01T02
27	395.922	Bohrbüchse 4.0, mit Gewinde		1	ST	B01T02
28	395.923	Bohrbüchse 6.0/5.0, lang, mit Gewinde		1	ST	B01T02
29	68.301.012	Einsatz Nr. 1 1/1 zu Vario Case 68.302.000		1	ST	B01T02

L01.302.000

Mittlerer Fixateur externe in Vario Case™

Box01/01

Tray 03

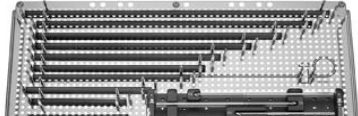
30	394.055	Stab mit Scharniergelenk für Fixateur externe		1	ST	B01T03
31	395.779	Kohlefaserstab Ø 8.0 mm, Länge 160 mm		2	ST	B01T03
33	395.782	Kohlefaserstab Ø 8.0 mm, Länge 200 mm		2	ST	B01T03
34	395.784	Kohlefaserstab Ø 8.0 mm, Länge 220 mm		2	ST	B01T03
35	395.786	Kohlefaserstab Ø 8.0 mm, Länge 240 mm		2	ST	B01T03
36	395.788	Kohlefaserstab Ø 8.0 mm, Länge 280 mm		2	ST	B01T03
37	395.792	Kohlefaserstab Ø 8.0 mm, Länge 320 mm		2	ST	B01T03
38	395.796	Kohlefaserstab Ø 8.0 mm, Länge 360 mm		1	ST	B01T03
39	395.797	Kohlefaserstab Ø 8.0 mm, Länge 400 mm	1	ST	B01T03	
40	68.301.013	Einsatz, unten, für Implantate und Stäbe für Grossen Fixateur externe, zu Nr. 68.301.000		1	ST	B01T03

L01.302.000

Mittlerer Fixateur externe in Vario Case™

B01M01

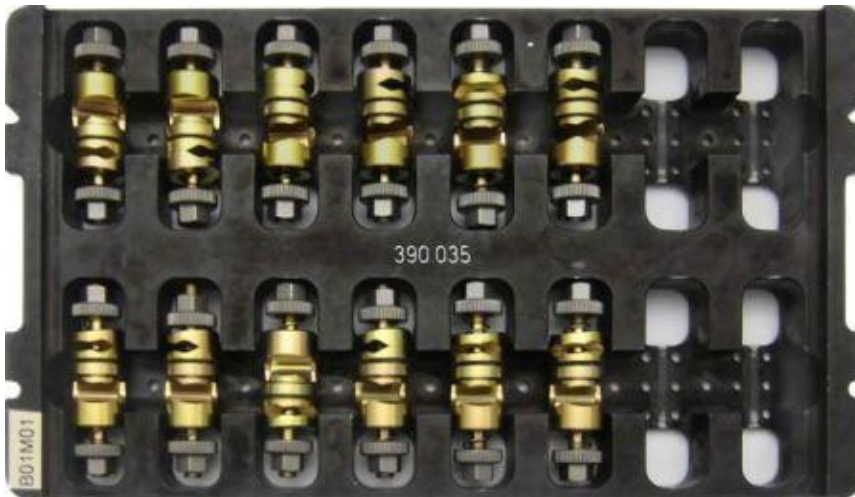

B01M02

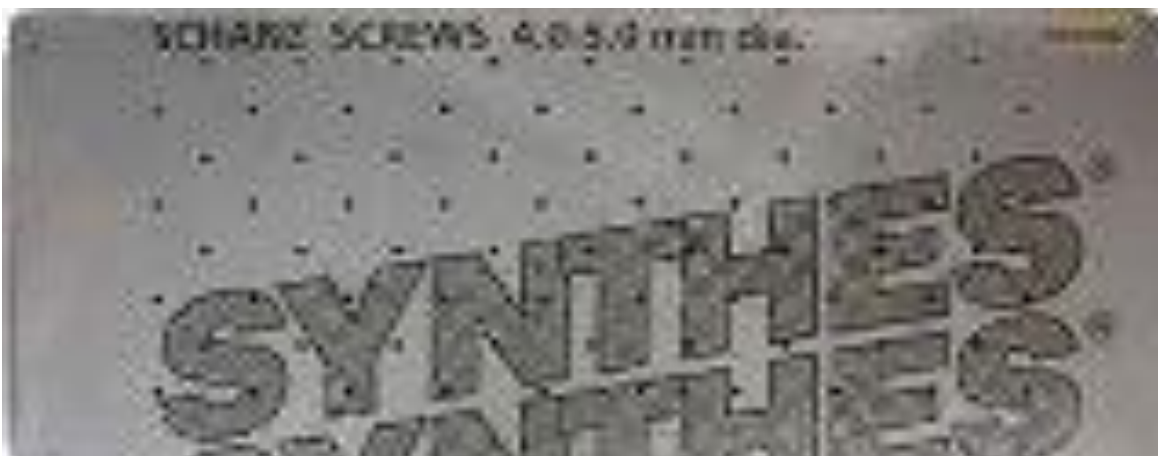

L01.302.000

Mittlerer Fixateur externe in Vario Case™

B01T01

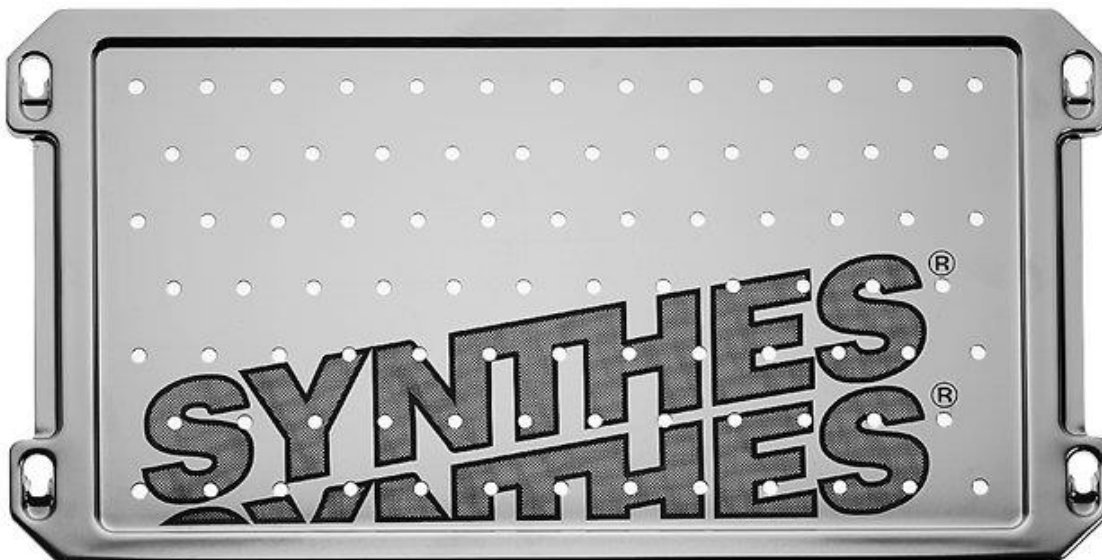
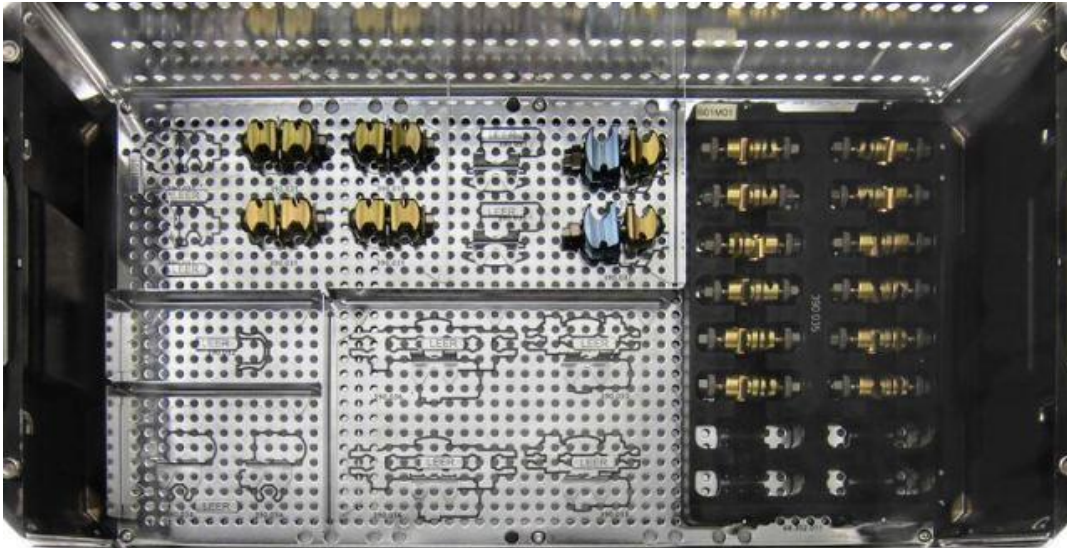

L01.302.000

Mittlerer Fixateur externe in Vario Case™

B01T02

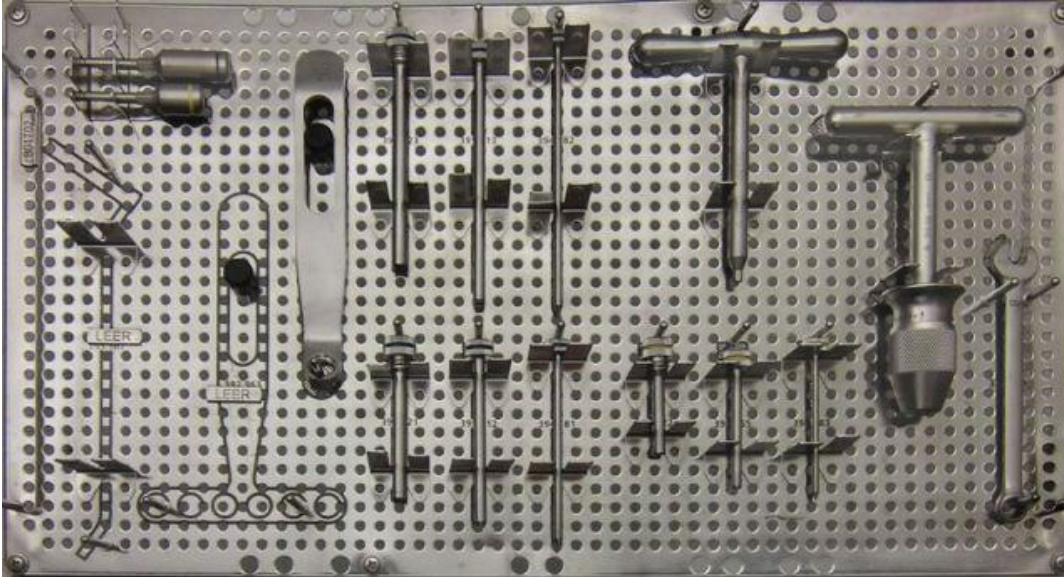

B01T03

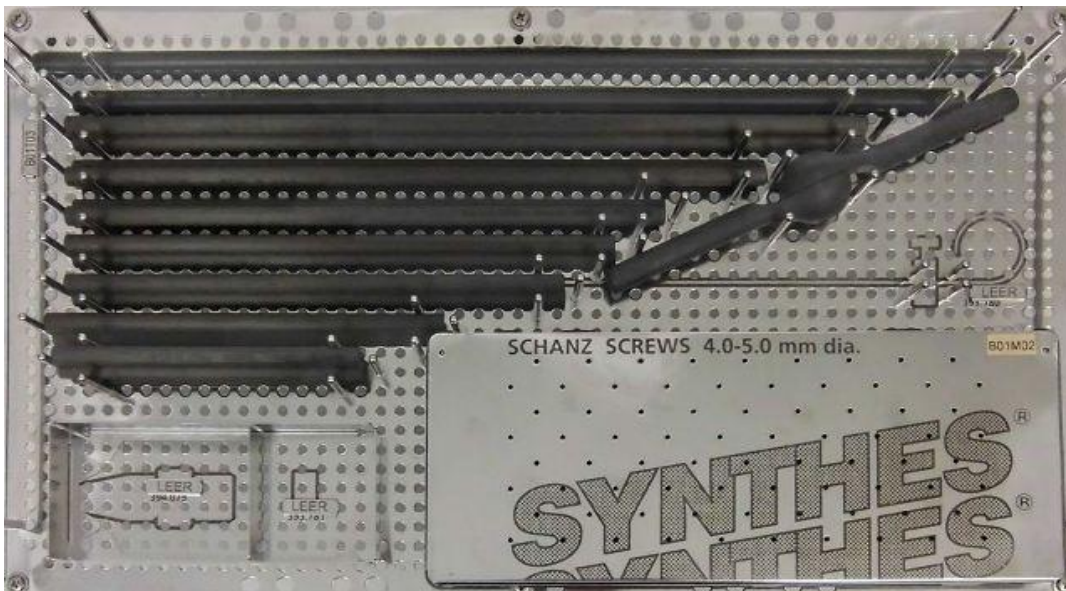

End of document