















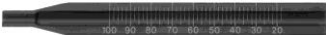

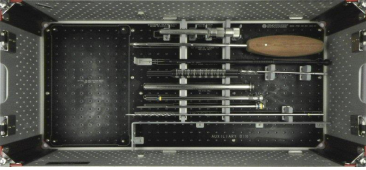











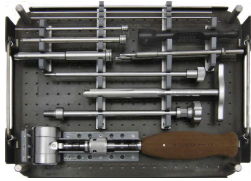









L01.001.300**Expert™ Humerusnagel Instrumente****Box01/01**

Pos.	Mat.Nr	Description		Qty	Unit	Location
Box01/01		Tray 01				
1	03.010.060	Spiralbohrer Ø 3.2 mm, kalibriert, Länge 340 mm, 3-lippig, für Schnellkupplung, zu Nr. 03.010.064		2	ST	B01T01
2	03.010.063	Gewebeschutzhülse 12.0/8.0, Länge 188 mm		1	ST	B01T01
3	03.010.064	Bohrbüchse 8.0/3.2, zu Nr. 03.010.063		1	ST	B01T01
4	03.010.069	Trokar Ø 3.2 mm, zu Nr. 03.010.064		1	ST	B01T01
5	03.010.072	Tiefenmessgerät für Verriegelungsschrauben, Messbereich bis 110 mm, zu Nr. 03.010.063		1	ST	B01T01
6	03.010.103	Spiralbohrer Ø 3.2 mm, kalibriert, Länge 145 mm, 3-lippig, für Schnellkupplung		2	ST	B01T01
7	03.010.106	Messstab für Spiralbohrer der Länge 145 mm, zu Nrn. 03.010.100 bis 03.010.105		1	ST	B01T01
8	03.010.107	Schraubenzieher Stardrive®, T25, Länge 330 mm		1	ST	B01T01
9	03.010.112	Haltehülse, mit Verschlussmechanismus		1	ST	B01T01
10	69.001.300	Graphic Case für Expert™ Humerusnagel, ohne Inhalt mit Deckel		1	ST	B01T01
		Deckel für Graphic Case 69.001.300		1	ST	B01T01
Box01/01		Tray 02				
11	03.010.025	Kirschnerdraht Ø 2.0 mm mit Trokarspitze, Länge 240 mm, Stahl		3	ST	B01T02
12	03.010.058	Kombihammer 400 g		1	ST	B01T02
13	03.010.059	Führungsstange für Kombihammer 400 g		1	ST	B01T02
14	03.010.086	Bohrbüchse 14.0/8.0, Länge 130 mm		1	ST	B01T02
15	03.010.087	Führungsbüchse 8.0/2.0 für Kirschnerdraht, Länge 140 mm		1	ST	B01T02
16	03.010.088	Trokar Ø 2.0 mm, Länge 150 mm		1	ST	B01T02
17	03.010.089	Spiralbohrer Ø 4.5 mm, durchbohrt		2	ST	B01T02

L01.001.300**Expert™ Humerusnagel Instrumente**

18	03.010.090	Längenmessgerät für Spiralklinge für Expert™ Humerusnagel		1	ST	B01T02
19	358.696	Einschlaginstrument für Spiralklinge, für UHN und PHN		1	ST	B01T02
20	358.697	Verbindungsschraube für Spiralklingen, für UHN und PHN		1	ST	B01T02
69.001.300.30	Einsatz 1/2 zu Case 69.001.300			1	ST	B01T02
Pos.	Mat.Nr	Description		Qty	Unit	Location
Box01/01	Tray 03					
21	03.010.022	Messlehre für Expert™ Humerusnagel		1	ST	B01T03
22	03.010.023	Messlehre für Nageldurchmesser für Expert™ Femurnägel, Länge 365 mm		1	ST	B01T03
23	03.010.038	Gewebeschutzhülse 10.0		1	ST	B01T03
24	03.010.039	Pfriem, durchbohrt		1	ST	B01T03
25	03.010.053	Verbindungsschraube, durchbohrt, für Expert™ Humerusnagel		1	ST	B01T03
26	03.010.054	Zielbügel für Expert™ Humerusnagel		1	ST	B01T03
27	03.010.055	Zielbügelauflauf für Spiralklingenverriegelung für Expert™ Humerusnagel		1	ST	B01T03
28	03.010.091	Zielbügelauflauf für Standardverriegelung, für Expert™ Humerusnagel		1	ST	B01T03
29	03.010.113	Kompressionsschraube für Expert™ Humerusnagel		1	ST	B01T03
30	292.260.01	Kirschnerdraht Ø 2.5 mm mit Dreikantspitze, Länge 280 mm, Stahl		10	ST	B01T03
31	310.440	Spiralbohrer Ø 4.5 mm, Länge 145/120 mm, 2-lippig, für Schnellkupplung		2	ST	B01T03
32	321.160	Ringgabelschlüssel Ø 11.0 mm		2	ST	B01T03

L01.001.300**Expert™ Humerusnagel Instrumente**

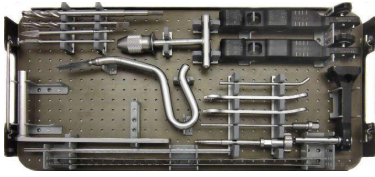
33	321.170	Stiftschlüssel Ø 4.5 mm, Länge 120 mm		1	ST	B01T03
34	332.062	Zapfenfräser, Länge 130 mm, für Schnellkupplung		1	ST	B01T03
35	358.682	Projektilfräser, für Schnellkupplung		1	ST	B01T03
36	360.050	Spiralbohrer Ø 10.0 mm, durchbohrt, Länge 190/140 mm, 3-lippig, für Dreibackenbohrfutter, für Kreuzbandplastik		1	ST	B01T03
37	393.105	Universalbohrfutter, klein, mit T-Griff		1	ST	B01T03
69.001.300.40	Einsatz 1/1 zu Case 69.001.300			1	ST	B01T03

Depuy Synthes GmbH
OrthoKit® Rental Service

Im Brunnenfeld 8
D-79224 Umkirch

www.depuythes.com



L01.001.300

Expert™ Humerusnagel Instrumente

B01T01

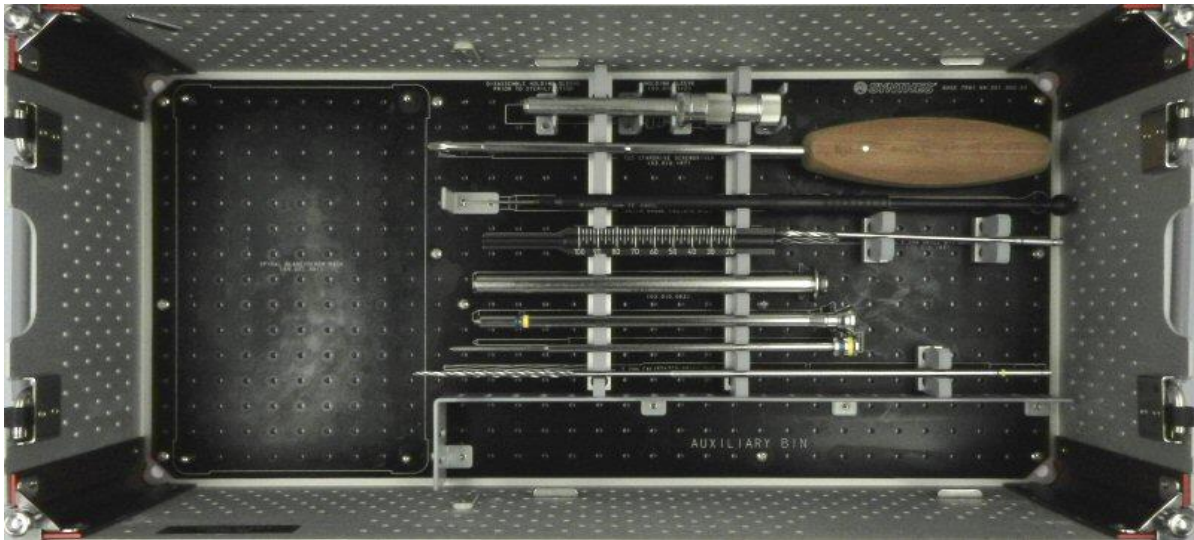

B01T02

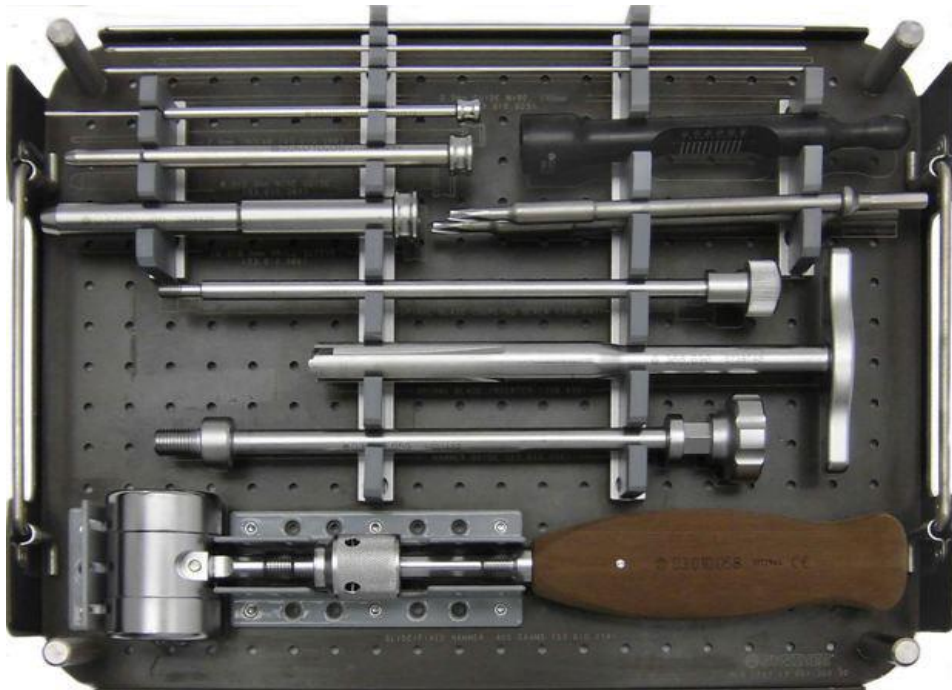

Depuy Synthes GmbH
OrthoKit® Rental Service

Im Brunnenfeld 8
D-79224 Umkirch

www.depuythes.com



L01.001.300

Expert™ Humerusnagel Instrumente

B01T03

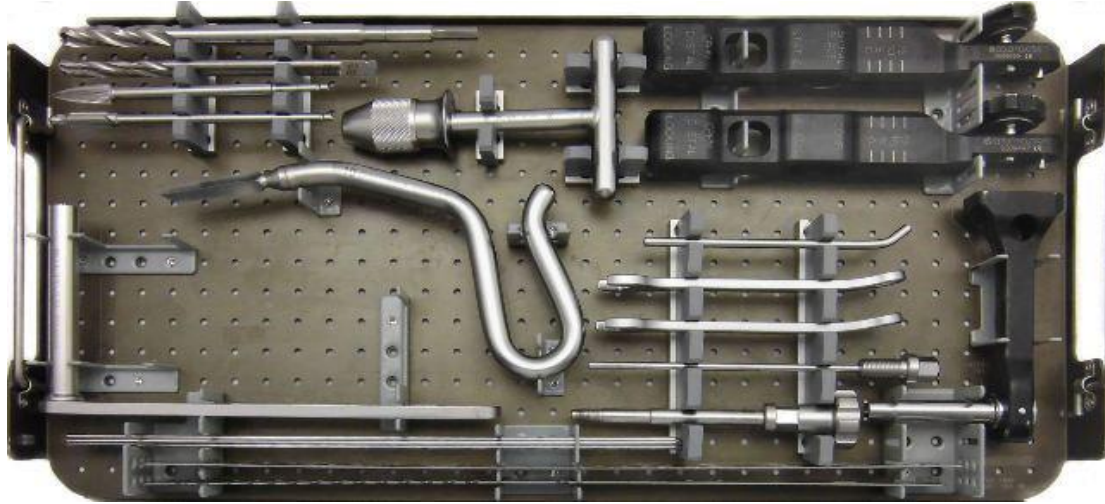

End of document