



Ethicon Product Catalog

Johnson & Johnson
MEDICAL DEVICES COMPANIES

Sutures

For complete indications, contraindications, warnings, precautions, and adverse reactions, please reference full package insert.

ETHICON
PART OF THE *Johnson & Johnson* FAMILY OF COMPANIES

Shaping
the future
of surgery

Table of Contents

General Information	3
Needle Index	10
True-to-Scale Needle Diagram	32
Suturing	37
Knotless Tissue Control Devices	40
Sutures: Plus Antibacterial.	55
Sutures: Absorbable	87
Sutures: Nonabsorbable	150

General Information	Needle Index	True-to-Scale Needle Diagram	Suturing	Knotless Tissue Control Devices	Sutures: Plus Antibacterial
Sutures: Absorbable	Sutures: Nonabsorbable				

General Information



General Information	Needle Index	True-to-Scale Needle Diagram	Suturing	Knotless Tissue Control Devices	Sutures: Plus Antibacterial
Sutures: Absorbable	Sutures: Nonabsorbable				

Explanation of a Typical Selection and Page

The needle type and size/shape are shown only for needle/suture combinations. A repeated needle type (eg RB-1, RB-1) indicates a "double-armed" suture, that is, a suture with a needle attached to each end.

About ATRALOC Needles

ATRALOC Needles are supplied in a variety of sizes, shapes and chord lengths. Surgeons should select the type of needle that, in their experience, is appropriate for the specific procedure and tissue.

Needle shapes are generally classified according to the degree of curvature of the body – 5/8, 1/2, 3/8, or 1/4 circle and straight – with taper, cutting, blunt points or TAPERCUT™ Surgical Needle tips.

In general, the same size of needle may be made from finer gauge wire for use in soft or delicate tissues and from heavier gauge wire for use in tough or fibrosed tissues (the surgeon's choice).

Needle Type/Needle Shape Symbol

Needle type and needle shape are shown in this subhead.

Material

Suture materials are designated by color and construction characteristics (eg Undyed Braided, Violet Braided, etc.)

Length

Suture length is shown in both inches and the approximate metric equivalent. Multi-strand means 3 or 8 strands per packet. These products are packaged 12, 24 or 36 packets per box.

The **CR** refers to CONTROL RELEASE Needle Sutures.

Product Name

Sutures and other Ethicon products are designated by trademarked and generic names.

Size

Suture size, denoting the diameter of the material, is in accordance with the United States Pharmacopeia (USP).

Needle Silhouette

Needle Silhouettes are shown in ACTUAL SIZE. The designated number above the needle, within the Needle Section, is the actual length measured in millimeters.

Code

Product codes ending in suffix G are packaged dozen packets to a box. Product codes ending in suffix H are packaged 3 dozen to a box. Product codes ending in suffix T are packaged 2 dozen packets to a box. In the few instances where no alphabetic suffix is in the product code, the number of packets per box is identified by a footnote. The number of strands per Multi-Strand packet appears on the left of suture length.

Needle Length

Needle length is the actual length measured in millimeters. Needle lengths can be found within the Needle Section and throughout the catalog to the right of the needle code. As a user you will find that many of these needle lengths have been rounded off. Recognize that the needles are not changing, but for consistency Ethicon has applied a rounding convention to all needle lengths. Due to timing differences, the box and label dimensions may not match the catalog exactly, but will be updated accordingly in the near future.

General Information	Needle Index	True-to-Scale Needle Diagram	Suturing	Knotless Tissue Control Devices	Sutures: Plus Antibacterial
Sutures: Absorbable	Sutures: Nonabsorbable				

Explanation of a Typical Selection and Page

The Major Characteristics of ATRALOC Needles are:

- They must be made from high quality stainless steel.
- They resist bending but are processed so that they will tend to bend before breaking.
- Taper points must be sharp and contoured for easy passage into tissues.
- Cutting points or edges must be sharp and free of burrs.
- On most ATRALOC Needles, a Super-Smooth finish is provided that permits the needle to penetrate and pass through with minimal resistance or drag.

- Ribbed needles – longitudinal ribs are provided on many ATRALOC Needles to increase the stability of the needle in the needleholder.
- The attachment of the needle to the suture material must be secure so that the needle will not separate from the suture material under normal use. An exception is the CONTROL RELEASE Needle suture principle, which facilitates fast separation of needle from suture when desirable.

MULTIPASS™ Needles

Elements of Needle Design

Needle design involves analyzing a surgical procedure and the density of the tissue involved in great detail. Ethicon engineers work continuously to improve upon their needle line.

The anatomy of the ideal surgical needle has three key factors that make up the ideal needle. -Alloy - Geometry - tip and body - Coating

The combination of these attributes is Ethicon MULTIPASS Needle Technology.

MULTIPASS Needles are the highest performing needles that Ethicon Products offers; a combination [or a balance] of three proprietary technologies ensure excellent strength, tissue penetration and control; pass after pass.

CONTROL RELEASE Needle Sutures

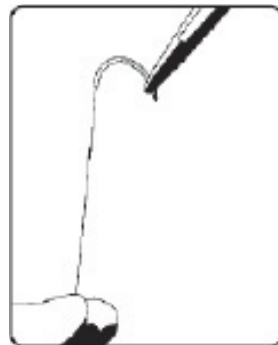

The needle is held securely in holder. Suture is grasped securely just below needle, pulling strand taut.

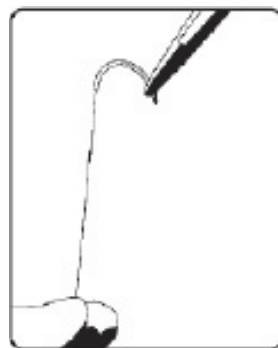

The needle is released with a straight tug of the needleholder.

Selection and Use of Needleholders

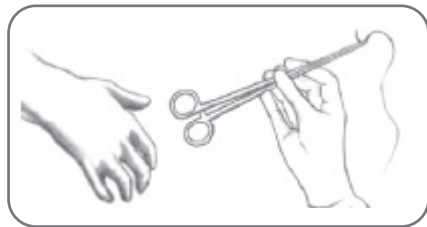
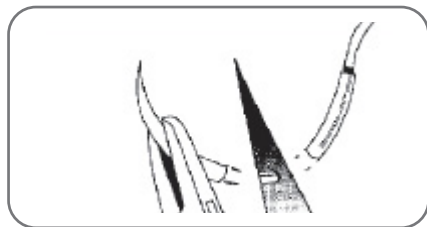
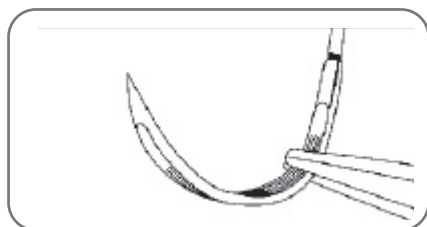
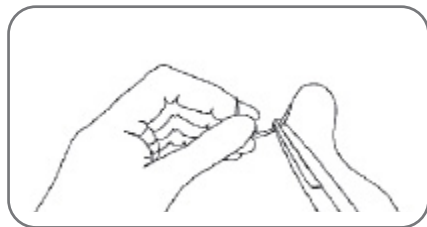

- The needleholder must be an appropriate size instrument for the size needle selected.
- It must be made from good quality steel with a secure jaw design.
- Needles should be grasped in an area about 1/3 to 1/2 of the distance from the swaged area to the point. Avoid placement on or near the swaged area.
- The needle should be placed securely in the tip of the needleholder jaws.
- Do not damage taper points or cutting edges when using the needleholder to pull the needle out through the tissue. Grasp as far back as possible.
- When placing the needle in tissue, any force applied should be in the direction following the curve of the needle.
- Do not take excessively large bites of tissue with small needles.
- Do not force or twist the needle in an effort to bring the point out through the tissue -withdraw the needle and replace tissue.
- Do not force a dull needle through tissue -obtain a new one.
- Avoid using the needle to bridge or approximate tissues for suturing.
- If the needle is held too tightly in a sharp or hard jawed or defective needleholder, the needle may be damaged or notched in such a manner that it will have more of a tendency to bend or break on successive passes through tissue.
- When the needle holder with needle is passed to the surgeon, the needle should be pointing in the right direction in which it will start to be used without need for readjustments.
- In some patients, the tissues may be tougher or fibrosed more than normal and require the use of a heavier gauge needle.
- In deep confined area, ideal positioning of the needle may not be possible. The surgeon should proceed with caution or use a heavier gauge needle.

An ATRALOC Needle is an instrument that complements the surgeon's skills. The variety of Ethicon needles offers the surgeon a choice of needles which are dependable for consistent quality and for practically all surgical applications.

General Information	Needle Index	True-to-Scale Needle Diagram	Suturing	Knotless Tissue Control Devices	Sutures: Plus Antibacterial
Sutures: Absorbable	Sutures: Nonabsorbable				

Steps to Create Performance

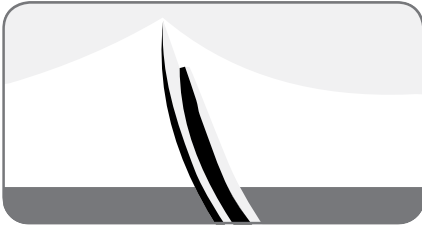

Conventional Needle

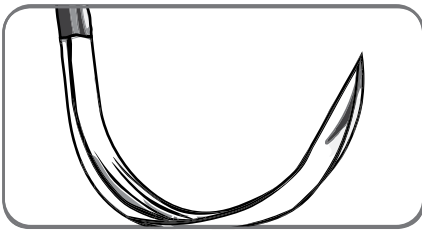

Needle Swaging

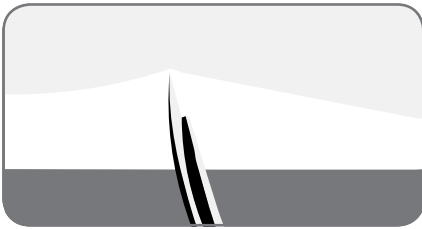

Super smooth

Controlled Manufacturing

Ethicon makes its own needle/sutures combinations. Each step, from raw material to finished needle, is carefully controlled for uniformly superior performance.

Strong, Sharp Micrograin Stainless Steel

Ethicon makes its needles from premium grade stainless steel formulated specifically for surgical use.

The Ethicon process controls the orientation of the micrograins so that ductility and strength are closely controlled - for strong needles that start sharp, and stay sharp, thus assuring easy passage through tissue.

Super-Smooth

Virtually all ATRALOC Needles have a micro-thin Super-Smooth finish that permits the needle to penetrate and pass through the toughest tissue with an almost fluid-like flow, with minimal resistance and virtually no drag, giving the surgeon a feeling of control.

Needle Swaging

Needles are permanently attached to the suture materials, eliminating the need for threading and providing a new, sharp needle each time. ATRALOC Needle swaging gives the surgeon a needle with an unbroken surface from end to end; without double strands, it draws through tissue easier and with less tissue trauma.

Ribbed for Security and Control

Longitudinal ribbing on the inside and outside curvatures of most needles has a cross-locking action in the needleholder, minimizing turning, rocking or twisting and thus providing unsurpassed needle control.

Shapes

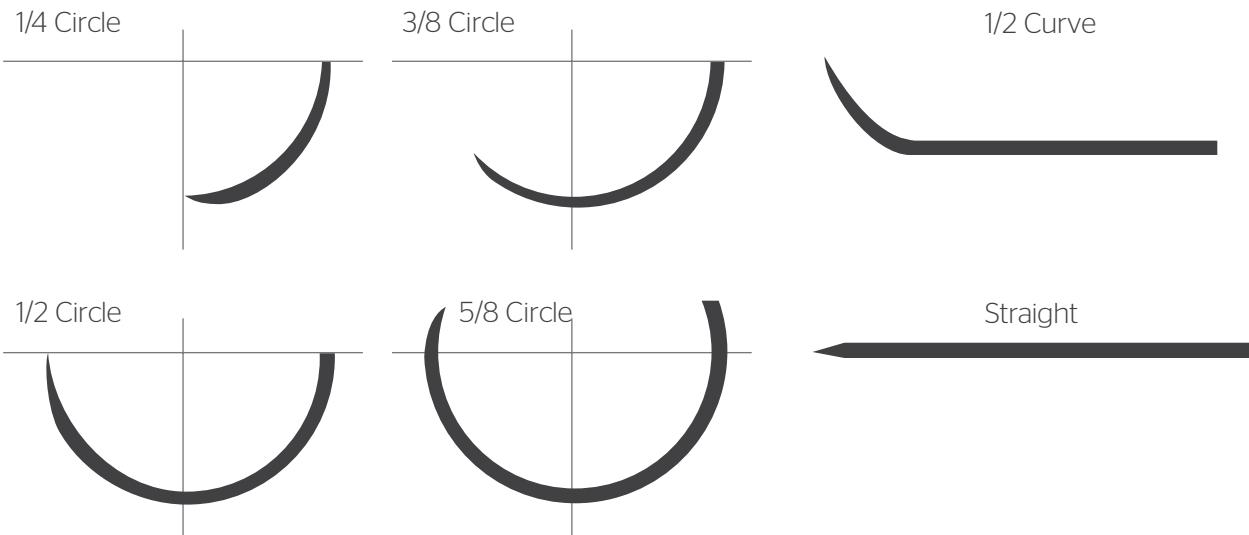

General Information	Needle Index	True-to-Scale Needle Diagram	Suturing	Knotless Tissue Control Devices	Sutures: Plus Antibacterial
Sutures: Absorbable	Sutures: Nonabsorbable				

Types



Taperpoint Needle

For soft, easily penetrated tissues.



TAPERCUT® Surgical Needle

Cutting tip, taper body. For tough tissue, like two needles in one.



ETHIGUARD® Blunt Point Needle

Taper body. For blunt dissection and suturing friable tissue.



Precision Point Needle

For delicate plastic or cosmetic surgery. Cutting tip electropolished for added sharpness.



Conventional Cutting Needle

Two opposing cutting edges, with a third on inside curve. Change in cross-section from a triangle cutting tip to a flattened body.



Precision Cosmetic Conventional Cosmetic Prime® Needle

For delicate plastic or cosmetic surgery. Conventional cutting tip and PRIME geometry for increased sharpness tip to a flattened body.



Reverse Cutting Needle

Cutting edge on outer curve. For tough, difficult-to-penetrate tissues.



MICRO-POINT* Surgical Needle (Spatula)

Thin, flat profile. Specially designed for ophthalmic anterior segment surgery.



Conventional Spatula Needle

Visibility of the point at bottom provides control of depth penetration.



MICRO-POINT* Reverse Cutting Needle

Cutting edge on outer curve. Extremely smooth. Extremely sharp for ophthalmic surgery.



ULTIMA* Needle (Spatula)

Reduced edge-angles provide better penetration. Readily facilitates knot rotation in ophthalmic surgery.



SABRELOC* Needle (Spatula)

Side-cutting spatula shaped edges. For layers of scleral or corneal tissue. Spatulated needle point is centered for maximum needle stability in thin sclera. Four equidistant and properly defined edges provide greater control.



VISI-BLACK* Surgical Needle

Slim Taper point needles with a black finish for improved visibility and penetration.

General Information	Needle Index	True-to-Scale Needle Diagram	Suturing	Knotless Tissue Control Devices	Sutures: Plus Antibacterial
Sutures: Absorbable	Sutures: Nonabsorbable				

Trademarks

- ATRALOC® Surgical Needle
- CONTROL RELEASE™ Needle or Needle Suture **CR**
- CS ULTIMA® Ophthalmic Needles
- DERMABOND ADVANCED® Topical Skin Adhesive
- DERMABOND® Mini Topical Skin Adhesive
- DERMABOND® PRINEO® Skin Closure System
- ETHALLOY® Needle Alloy
- ETHIBOND™ Extra Polyester Suture
- ETHIBOND™ Polyester Suture
- ETHIGUARD® Blunt Point Needle
- ETHILON® Nylon Suture
- ETHI-PACK™ Pre-cut Sutures
- EVERPOINT® Cardiovascular Needles **EVP**
- HEMO-SEAL™ Needle Suture **HS**
- J-VAC® Closed Wound Drainage System
- J-VAC® Bulb Suction Reservoir
- J-VAC® Reservoir
- J-VAC® Drainage Adapter
- J-VAC® Silicon Drain
- LAPRA-TY® Suture Clip
- LIGAPAK™ Dispensing Reel
- LIGAPAK® Ligature
- MERSILENE® Polyester Fiber Suture
- MERSILENE® Polyester Fiber Strip
- MICRO-POINT® Surgical Needle
- MONOCRYL® (poliglecaprone 25) Suture
- MONOCRYL® Plus Antibacterial (poliglecaprone 25) Suture
- MULTIPLASS® Needle 
- NUROLON® Nylon Suture
- PC PRIME® Needle
- PDS® (polydioxanone) Suture
- PDS® II (polydioxanone) Suture
- PDS® Plus Antibacterial (polydioxanone) Suture
- PERMA-HAND® Silk Suture
- PROLENE® Polypropylene Suture
- PRONOVA® Poly (Hexafluoropropylene - VDF) Suture
- PROXI-STRIP Skin Closure
- PC PRIME® Needle
- RELAY Suture Delivery System
- RELAY Suture Package
- SABRELOC® Spatula Needle
- STRATAFIX™ Knotless Tissue Control Devices
- STRATAFIX™ Spiral Knotless Tissue Control Device
- STRATAFIX™ Spiral PDO Knotless Tissue Control Device
- STRATAFIX™ Spiral PGA-PCL Knotless Tissue Control Device
- STRATAFIX™ Spiral Polypropylene Knotless Tissue Control Device
- STRATAFIX™ Symmetric Knotless Tissue Control Device
- STRATAFIX™ Symmetric PDS™ Plus Knotless Tissue Control Device
- SUTUPAK® Pre-cut Sterile Sutures
- TAPERCUT® Surgical Needle
- VICRYL® (polyglactin 910) Knitted Mesh
- VICRYL® (polyglactin 910) Woven Mesh
- VICRYL® (polyglactin 910) Mesh Bags
- VICRYL® (polyglactin 910) Perirenal Mesh Bag
- VICRYL® (polyglactin 910) Perisplenic Mesh Bag
- VICRYL® (polyglactin 910) Perihepatic Mesh Bags
- VICRYL® (polyglactin 910) Perihepatic Right Lobe Mesh Bag
- VICRYL® (polyglactin 910) Perihepatic Left Lobe Mesh Bag
- Coated VICRYL® (polyglactin 910) Suture
- Coated VICRYL® Plus Antibacterial (polyglactin 910) Suture
- VICRYL RAPIDE™ (polyglactin 910) Suture
- VISI-BLACK™ Surgical Needle **VB**

General Information	Needle Index	True-to-Scale Needle Diagram	Suturing	Knotless Tissue Control Devices	Sutures: Plus Antibacterial
Sutures: Absorbable	Sutures: Nonabsorbable				

Needle Index



General Information	Needle Index	True-to-Scale Needle Diagram	Suturing	Knotless Tissue Control Devices	Sutures: Plus Antibacterial
Sutures: Absorbable	Sutures: Nonabsorbable	Topical Skin Adhesives			

1/4 Circle

Taperpoint



Needles	Available Products
BV30-2	

Tapercut



Needles	Available Products
V75-3	ETHILON
V100-3	ETHILON
RV-2	

CIF-4

PROLENE

SABERLOC® Spatula



Needles	Available Products
S-4	GUT CHROMIC, MERSILENE
S-29	COATED VICRYL
S-24	MERSILENE

S-14

COATED VICRYL, GUT CHROMIC, GUT PLAIN, ETHILON, MERSILENE, PERMA HAND SILK

General Information	Needle Index	True-to-Scale Needle Diagram	Suturing	Knotless Tissue Control Devices	Sutures: Plus Antibacterial
Sutures: Absorbable	Sutures: Nonabsorbable				

1/4 Circle

ULTIMA® Spatula



Needles	Available Products
CS100-8	
CS90-6	VICRYL
CTC-6L	PROLENE
CTC-6	
TG100-8	VICRYL, GUT CHROMIC, ETHILON

3/8 Circle

Taperpoint

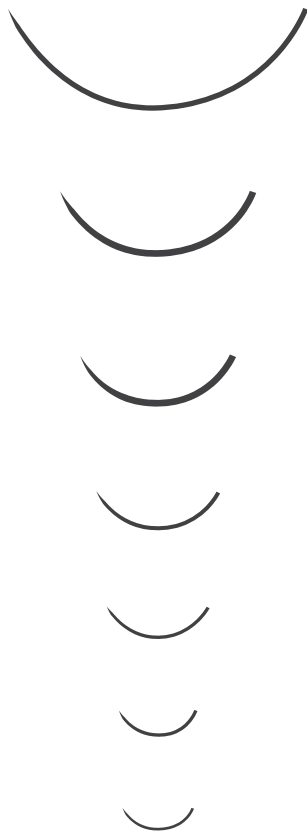

Needles	Available Products
TE-1	
TE	TEMPORARY PACING WIRE
TE-2	
BB-1	TEMPORARY PACING WIRE
BB	STRATAFIX SPIRAL MONOCRYL PLUS, GUT CHROMIC, ETHIBOND, PROLENE, PRONOVA, PERMA HAND SILK
C-1	PDS PLUS, GUT CHROMIC, PDS II, ETHIBOND, PROLENE, PROLENE HS, PRONOVA, PERMA HAND SILK
BV	PDS PLUS, PDS II, PROLENE, PRONOVA

General Information	Needle Index	True-to-Scale Needle Diagram	Suturing	Knotless Tissue Control Devices	Sutures: Plus Antibacterial
Sutures: Absorbable	Sutures: Nonabsorbable				

3/8 Circle

Taperpoint



Needles	Available Products
BV-1	PDS PLUS, PDS II, ETHIBOND, PROLENE, PROLENE HS, PRONOVA, PERMA HAND SILK
BV175-8	PROLENE, PRONOVA
BV175-7	PROLENE, PRONOVA
BV175-6	PROLENE, PRONOVA
BV175-5	
BV130-5	COATED VICRYL, ETHILON, PROLENE, PRONOVA
BV130-4	COATED VICRYL, ETHILON
BV130-3	ETHILON
BV100-4	ETHILON, PROLENE
BV100-3	VICRYL
BV75-4	ETHILON
BV75-3	ETHILON, PROLENE

Tapercut



Needles	Available Products
V-26	STRATAFIX SPIRAL PDO Knotless Tissue Control Device

General Information	Needle Index	True-to-Scale Needle Diagram	Suturing	Knotless Tissue Control Devices	Sutures: Plus Antibacterial
Sutures: Absorbable	Sutures: Nonabsorbable				

3/8 Circle

Tapercut



Needles	Available Products
V-3	
V-4	STRATAFIX SPIRAL PDO, ETHIBOND, PROLENE, PERMA HAND SILK
V-18	
CC-1	ETHIBOND, PROLENE, PRONOVA, PERMA HAND SILK
CC	PROLENE
V130-5	COATED VICRYL
V130-4	COATED VICRYL
V130-3	ETHILON

Reverse Cutting

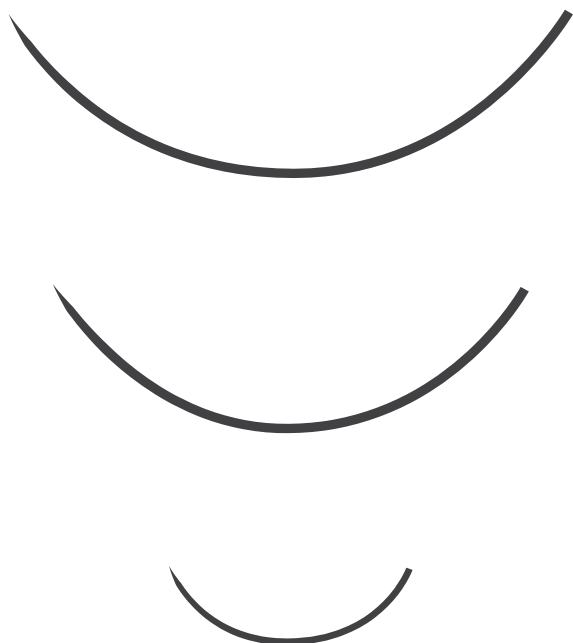

Needles	Available Products
KP-3	
LR	ETHIBOND, ETHILON, MERSILENE, PROLENE, STEEL, PERMA HAND SILK
FSLX	ETHILON, PROLENE, STEEL, PERMA HAND SILK

General Information	Needle Index	True-to-Scale Needle Diagram	Suturing	Knotless Tissue Control Devices	Sutures: Plus Antibacterial
Sutures: Absorbable	Sutures: Nonabsorbable				

3/8 Circle

Reverse Cutting



Needles	Available Products
FSL	COATED VICRYL PLUS, COATED VICRYL, ETHILON, NUROLON, PROLENE, PERMA HAND SILK
FS	STRATAFIX SPIRAL PDS PLUS, STRATAFIX SPIRAL PDO, STRATAFIX SPIRAL PGA-PCL, COATED VICRYL PLUS, COATED VICRYL, ETHIBOND, ETHILON, MERSILENE, NUROLON, PROLENE, PERMA HAND SILK
FS-1	STRATAFIX SPIRAL PGA-PCL, COATED VICRYL PLUS, PDS PLUS, COATED VICRYL, GUT CHROMIC, GUT PLAIN, PDS II, ETHIBOND, ETHILON, MERSILENE, PROLENE, STEEL, PERMA HAND SILK
FS-2	STRATAFIX SPIRAL PDO, STRATAFIX SPIRAL PGA-PCL, COATED VICRYL PLUS, PDS PLUS, COATED VICRYL, GUT CHROMIC, GUT PLAIN, PDS II, ETHIBOND, ETHILON, MERSILENE, PROLENE, STEEL, PERMA HAND SILK
FS-3	
M-2	GUT CHROMIC
C-3	COATED VICRYL, GUT CHROMIC, ETHILON, PERMA HAND SILK
C-2	ETHILON, PERMA HAND SILK

3/8 Circle

Conventional Cutting



Needles	Available Products
CR-1	GUT CHROMIC
CPS-3	
PC-5	COATED VICRYL PLUS, MONOCRYL PLUS, PDS PLUS, COATED VICRYL, MONOCRYL, PDS II, ETHILON, PROLENE, PERMA HAND SILK
PC-3	COATED VICRYL PLUS, MONOCRYL PLUS, PDS PLUS, COATED VICRYL, VICRYL RAPIDE, MONOCRYL, PDS II, ETHILON, PROLENE, PERMA HAND SILK
PC-1	COATED VICRYL PLUS, MONOCRYL PLUS, PDS PLUS, COATED VICRYL, VICRYL RAPIDE, GUT PLAIN, MONOCRYL, PDS II, ETHILON, NUROLON, PROLENE

Precision Point Reverse Cutting

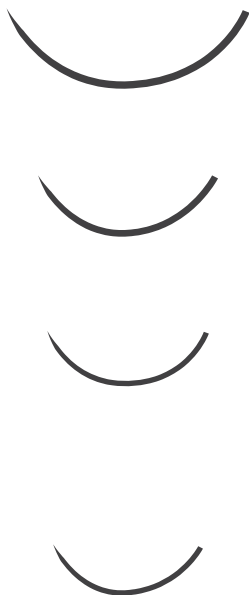

Needles	Available Products
PSLX	ETHILON, PERMA HAND SILK
PSL	STRATAFIX SPIRAL MONOCRYL PLUS, STRATAFIX SPIRAL PGA-PCL, COATED VICRYL PLUS, COATED VICRYL, ETHILON, PERMA HAND SILK
PS	STRATAFIX SPIRAL MONOCRYL PLUS, STRATAFIX SPIRAL PDS PLUS, GUT CHROMIC, ETHILON, PERMA HAND SILK
PS-1	STRATAFIX SPIRAL MONOCRYL PLUS, STRATAFIX SPIRAL PDS PLUS, STRATAFIX SYMMETRIC PDS PLUS, STRATAFIX SPIRAL PGA-PCL, COATED VICRYL PLUS, MONOCRYL PLUS, PDS PLUS, COATED VICRYL, VICRYL RAPIDE, GUT PLAIN, MONOCRYL, PDS II, ETHILON, PROLENE, PERMA HAND SILK

General Information	Needle Index	True-to-Scale Needle Diagram	Suturing	Knotless Tissue Control Devices	Sutures: Plus Antibacterial
Sutures: Absorbable	Sutures: Nonabsorbable				

3/8 Circle

Precision Point Reverse Cutting



Needles	Available Products
PS-2	STRATAFIX SPIRAL MONOCRYL PLUS, STRATAFIX SPIRAL PDS PLUS, STRATAFIX SYMMETRIC PDS PLUS, STRATAFIX SPIRAL PDO, STRATAFIX SPIRAL PGA-PCL, COATED VICRYL PLUS, MONOCRYL PLUS, PDS PLUS, COATED VICRYL, VICRYL RAPIDE, GUT CHROMIC, GUT PLAIN, MONOCRYL, PDS II, ETHIBOND, ETHILON, PROLENE, PERMA HAND SILK
PS-3	COATED VICRYL PLUS, COATED VICRYL, GUT CHROMIC, GUT PLAIN, ETHIBOND, ETHILON, PROLENE, PERMA HAND SILK
P-3	COATED VICRYL PLUS, MONOCRYL PLUS, PDS PLUS, COATED VICRYL, VICRYL RAPIDE, GUT CHROMIC, GUT PLAIN, MONOCRYL, PDS II, ETHIBOND, ETHILON, MERSILENE, PROLENE, PERMA HAND SILK
P-1	COATED VICRYL PLUS, MONOCRYL PLUS, PDS PLUS, COATED VICRYL, VICRYL RAPIDE, GUT PLAIN, MONOCRYL, PDS II, ETHIBOND, ETHILON, PROLENE, PERMA HAND SILK
P-6	ETHILON, PROLENE

ULTIMA® Spatula



Needles	Available Products
TG140-8	COATED VICRYL, VICRYL, GUT CHROMIC, GUT PLAIN, ETHILON, PROLENE, PERMA HAND SILK
TG140-6	COATED VICRYL, ETHILON
VAS100-4	ETHILON
CS140-8	ETHILON
CS140-6	VICRYL, ETHILON, MERSILENE, PROLENE

1/2 Circle

Blunt Point



Needles	Available Products
BP	SURGICAL GUT SUTURE - CHROMIC MERSILENE SUTURE



BP-1	MERSILENE SUTURE
------	------------------



BP-2	SURGICAL GUT SUTURE - CHROMIC
------	-------------------------------



TPB-1	COATED VICRYL PLUS SUTURE PDS PLUS SUTURE
-------	----------------------------------------------



CTXB	STRATAFIX SYMMETRIC PDS PLUS, COATED VICRYL PLUS, PDS PLUS, COATED VICRYL, MONOCRYL, PDS II, PROLENE
------	------------------------------------------------------------------------------------------------------



CTB	COATED VICRYL PLUS, PDS PLUS
-----	------------------------------



CTB-1	STRATAFIX SYMMETRIC PDS PLUS, COATED VICRYL PLUS, MONOCRYL PLUS, PDS PLUS, COATED VICRYL, MONOCRYL, PDS II, PROLENE
-------	---------------------------------------------------------------------------------------------------------------------

General Information	Needle Index	True-to-Scale Needle Diagram	Suturing	Knotless Tissue Control Devices	Sutures: Plus Antibacterial
Sutures: Absorbable	Sutures: Nonabsorbable				

1/2 Circle

Blunt Point



Needles	Available Products
CTB-2	COATED VICRYL PLUS, PDS PLUS
SHB	COATED VICRYL PLUS, MONOCRYL PLUS, PDS PLUS COATED VICRYL, MONOCRYL

Taperpoint



Needles	Available Products
XXLH	
XLH-1	
XLH	COATED VICRYL PLUS, PDS PLUS, COATED VICRYL, GUT CHROMIC, GUT PLAIN, PDS II, ETHIBOND, PROLENE
LH	GUT CHROMIC
MH	STRATAFIX SPIRAL PDO, STRATAFIX SPIRAL PGA-PCL , COATED VICRYL PLUS, COATED VICRYL, GUT CHROMIC, MONOCRYL, ETHIBOND, PROLENE, PRONOVA, PERMA HAND SILK
MH-1	

General Information	Needle Index	True-to-Scale Needle Diagram	Suturing	Knotless Tissue Control Devices	Sutures: Plus Antibacterial
Sutures: Absorbable	Sutures: Nonabsorbable				

1/2 Circle

Taperpoint



Needles	Available Products
SH	STRATAFIX SPIRAL MONOCRYL PLUS, STRATAFIX SPIRAL PDS PLUS, STRATAFIX SYMMETRIC PDS PLUS, STRATAFIX SPIRAL PDO, STRATAFIX SPIRAL PGA-PCL, COATED VICRYL PLUS, MONOCRYL PLUS, PDS PLUS, COATED VICRYL, VICRYL RAPIDE, GUT CHROMIC, GUT PLAIN, MONOCRYL, PDS II, ETHIBOND, MERSILENE, NUROLON, PROLENE, PROLENE HS, PRONOVA, PERMA HAND SILK
SH-1	STRATAFIX SPIRAL POLYPROPYLENE, COATED VICRYL PLUS, PDS PLUS, COATED VICRYL, GUT CHROMIC, MONOCRYL, PDS II, ETHIBOND, NUROLON, PROLENE, PRONOVA, PERMA HAND SILK
RS	
SH-2	ETHIBOND, PROLENE HS
RB-1	STRATAFIX SPIRAL MONOCRYL PLUS, STRATAFIX SPIRAL PDS PLUS, STRATAFIX SPIRAL PGA-PCL, COATED VICRYL PLUS, MONOCRYL PLUS, PDS PLUS, COATED VICRYL, VICRYL RAPIDE, GUT CHROMIC, GUT PLAIN, MONOCRYL, PDS II, ETHIBOND, NUROLON, PROLENE, PROLENE HS, PRONOVA, PERMA HAND SILK
UCLX	
RB-2	COATED VICRYL PLUS, PDS PLUS, PDS II, PROLENE, PROLENE HS, PRONOVA, PERMA HAND SILK
UCL	PDS PLUS, PDS II, ETHIBOND
TF	COATED VICRYL PLUS, PDS PLUS, COATED VICRYL, MONOCRYL, PDS II, ETHIBOND, NUROLON, PROLENE, PERMA HAND SILK
RB-3	PROLENE
RB-4	

General Information	Needle Index	True-to-Scale Needle Diagram	Suturing	Knotless Tissue Control Devices	Sutures: Plus Antibacterial
Sutures: Absorbable	Sutures: Nonabsorbable				

1/2 Circle

Taperpoint



Needles	Available Products
TF-1	
TF-4	
TF-6	
BVH100-3	ETHILON

Tapercut

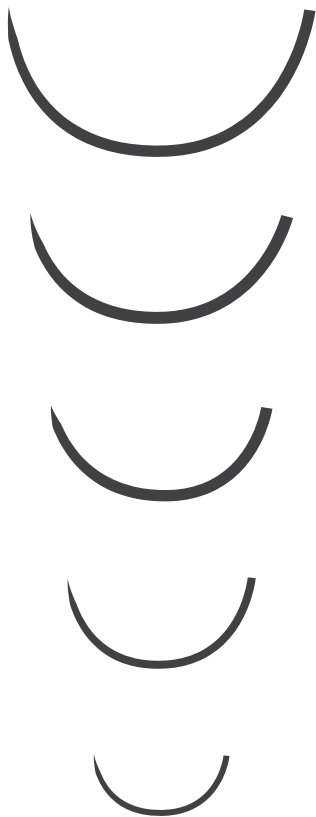

Needles	Available Products
V-56	STEEL
V-40	ETHIBOND, STEEL
V-37	ETHIBOND, STEEL
V-34	STRATAFIX SPIRAL PDS PLUS, COATED VICRYL PLUS, COATED VICRYL, VICRYL RAPIDE, GUT CHROMIC, GUT PLAIN, MONOCRYL, ETHIBOND, PROLENE
V-7	STRATAFIX SPIRAL PDS PLUS, GUT PLAIN, ETHIBOND, PROLENE, PRONOVA, PERMA HAND SILK

General Information	Needle Index	True-to-Scale Needle Diagram	Suturing	Knotless Tissue Control Devices	Sutures: Plus Antibacterial
Sutures: Absorbable	Sutures: Nonabsorbable				

1/2 Circle

Tapercut



Needles	Available Products
V-6	
V-5	PDS PLUS, GUT CHROMIC, PDS II, ETHIBOND, PROLENE, PERMA HAND SILK

Reverse Cutting



Needles	Available Products
LS	
LS-1	STEEL
CPXX	
CPX	COATED VICRYL PLUS, PDS PLUS, COATED VICRYL, PDS II
CP	COATED VICRYL PLUS, COATED VICRYL, GUT CHROMIC, PDS II, NUROLON

General Information	Needle Index	True-to-Scale Needle Diagram	Suturing	Knotless Tissue Control Devices	Sutures: Plus Antibacterial
Sutures: Absorbable	Sutures: Nonabsorbable				

1/2 Circle

Reverse Cutting



Needles	Available Products
CP-1	STRATAFIX SPIRAL MONOCRYL PLUS, COATED VICRYL PLUS, MONOCRYL PLUS, PDS PLUS, COATED VICRYL, GUT CHROMIC, GUT PLAIN, MONOCRYL, PDS II, STEEL, PERMA HAND SILK
CP-2	STRATAFIX SPIRAL MONOCRYL PLUS, STRATAFIX SPIRAL PDS PLUS, STRATAFIX SPIRAL PDO, STRATAFIX SPIRAL PGA-PCL, COATED VICRYL PLUS, PDS PLUS, COATED VICRYL, GUT CHROMIC, PDS II, NUROLON
OS-8	STRATAFIX SPIRAL PDS PLUS, STRATAFIX SPIRAL PDO, COATED VICRYL PLUS, COATED VICRYL, ETHIBOND, NUROLON
OS-6	STRATAFIX SPIRAL PDS PLUS, STRATAFIX SYMMETRIC PDS PLUS, STRATAFIX SPIRAL PDO, COATED VICRYL PLUS, PDS PLUS, COATED VICRYL, PDS II, ETHIBOND
OS-4	COATED VICRYL PLUS, PDS PLUS, COATED VICRYL, PDS II, ETHIBOND
OS-2	ETHIBOND
X-1	COATED VICRYL PLUS, COATED VICRYL, GUT PLAIN, ETHILON, NUROLON, PERMA HAND SILK
X-6	
X-8	
J-1	COATED VICRYL, GUT CHROMIC, PERMA HAND SILK
M-1	GUT CHROMIC, GUT PLAIN

General Information	Needle Index	True-to-Scale Needle Diagram	Suturing	Knotless Tissue Control Devices	Sutures: Plus Antibacterial
Sutures: Absorbable	Sutures: Nonabsorbable				

1/2 Circle

Reverse Cutting



Needles	Available Products
PS-4C	COATED VICRYL PLUS, COATED VICRYL, GUT CHROMIC
PS-4	STRATAFIX SPIRAL MONOCRYL PLUS, COATED VICRYL PLUS, PDS PLUS, COATED VICRYL, GUT CHROMIC, GUT PLAIN, PDS II, ETHIBOND, ETHILON, PROLENE, PERMA HAND SILK
PS-5	COATED VICRYL PLUS, COATED VICRYL, GUT CHROMIC, PROLENE
PS-6	COATED VICRYL PLUS, COATED VICRYL, GUT CHROMIC, MONOCRYL
P-2	COATED VICRYL PLUS, PDS PLUS, COATED VICRYL, GUT CHROMIC, GUT PLAIN, PDS II
G-2	GUT CHROMIC
G-7	PERMA HAND SILK

Conventional Cutting



Needles	Available Products
PC-12	COATED VICRYL, MONOCRYL, ETHILON

SABERLOC® Spatula



Needles	Available Products
S-28	COATED VICRYL
S-2	GUT CHROMIC, MERSILENE
S-12	
S-22	ETHILON

General Information	Needle Index	True-to-Scale Needle Diagram	Suturing	Knotless Tissue Control Devices	Sutures: Plus Antibacterial
Sutures: Absorbable	Sutures: Nonabsorbable				

1/2 Circle

ULTIMA® Spatula



Needles	Available Products
OPS-5	
TG175-8	ETHILON
TG160-8	COATED VICRYL
TG160-6	COATED VICRYL, ETHILON
TG160-4	ETHILON, MERSILENE
TG160-6	COATED VICRYL, ETHILON
CS175-8	GUT CHROMIC, ETHILON
CS160-8	VICRYL, ETHILON, PROLENE
CS175-6	ETHILON
CS160-6	VICRYL, ETHILON, MERSILENE, PROLENE
CS160-4	
CSM-6	ETHILON

5/8 Circle

Taperpoint



Needles	Available Products
UR-4	COATED VICRYL, GUT CHROMIC
UR-5	COATED VICRYL PLUS, MONOCRYL PLUS, COATED VICRYL, GUT CHROMIC, MONOCRYL
UR-6	STRATAFIX SPIRAL PDS PLUS, COATED VICRYL PLUS, MONOCRYL PLUS, COATED VICRYL, GUT CHROMIC, MONOCRYL

General Information	Needle Index	True-to-Scale Needle Diagram	Suturing	Knotless Tissue Control Devices	Sutures: Plus Antibacterial
Sutures: Absorbable	Sutures: Nonabsorbable				

5/8 Circle

Taperpoint



Needles	Available Products
MF	
MF-1	
TF-5	PERMA HAND SILK

Straight

Taperpoint



Needles	Available Products
ST	
ST-1	PERMA HAND SILK
ST-3	
ST-4	STRATAFIX SPIRAL MONOCRYL PLUS, STRATAFIX SPIRAL PDS PLUS, PDS PLUS, PDS II
ST100-3	ETHILON

Taperpoint



Needles	Available Products
V-47	PROLENE

General Information	Needle Index	True-to-Scale Needle Diagram	Suturing	Knotless Tissue Control Devices	Sutures: Plus Antibacterial
Sutures: Absorbable	Sutures: Nonabsorbable				

Straight

Reverse Cutting

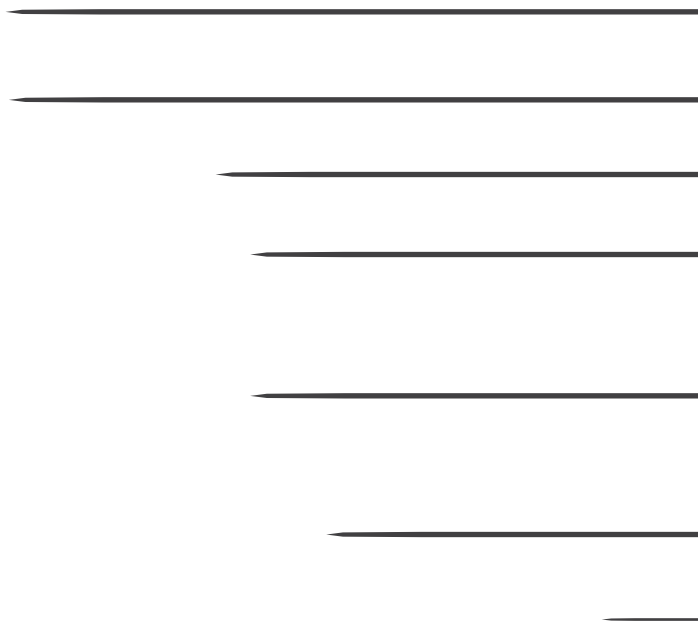

Needles	Available Products
SKS-3	TEMPORARY PACING WIRE
SK-3	
BN	
SKS	TEMPORARY PACING WIRE
KS	COATED VICRYL PLUS, MONOCRYL PLUS, PDS PLUS, COATED VICRYL, GUT CHROMIC, GUT PLAIN, MONOCRYL, PDS II, ETHIBOND, ETHILON, PROLENE, STEEL, PERMA HAND SILK
TS	PROLENE
SC-1	GUT PLAIN

SABERLOC® Spatula



Needles	Available Products
STC-6	PROLENE

Ski

Taperpoint



Needles	Available Products
PB-1	

General Information	Needle Index	True-to-Scale Needle Diagram	Suturing	Knotless Tissue Control Devices	Sutures: Plus Antibacterial
Sutures: Absorbable	Sutures: Nonabsorbable				

Trocar

Trocar

Needles	Available Products
STP-10	PDS II, ETHIBOND

General Information	Needle Index	True-to-Scale Needle Diagram	Suturing	Knotless Tissue Control Devices	Sutures: Plus Antibacterial
Sutures: Absorbable	Sutures: Nonabsorbable				

Compound Curve

SABERLOC® Spatula



Needles	Available Products
TG6-C	

ULTIMA® Reverse Cutting



Needles	Available Products
CS-C-6	ETHILON, PROLENE

Sternum

Taperpoint



Needles	Available Products
CCS-1	COATED VICRYL, PDS II, STEEL

CCS	ETHIBOND, STEEL
-----	-----------------

Center Point Spatula

SABERLOC® Spatula



Needles	Available Products
RD-1	COATED VICRYL, ETHILON, MERSILENE

ULTIMA® Spatula



Needles	Available Products
CS-B-6	

Endoscopy

Taperpoint



Needles	Available Products
TN	COATED VICRYL
EN-2	
EN-1	
EN-S	

General Information	Needle Index	True-to-Scale Needle Diagram	Suturing	Knotless Tissue Control Devices	Sutures: Plus Antibacterial
Sutures: Absorbable	Sutures: Nonabsorbable				

Endoscopy

Tapercut



Needles	Available Products
V-38	COATED VICRYL, PDS II
EN-4	
EN-3	
DT-6	
EN-5	

General Information	Needle Index	True-to-Scale Needle Diagram	Suturing	Knotless Tissue Control Devices	Sutures: Plus Antibacterial
Sutures: Absorbable	Sutures: Nonabsorbable				

True-to-Scale Needle Diagram





True-to-Scale Needle Diagram



Cutting Edge



General Information	Needle Index	True-to-Scale Needle Diagram	Suturing	Knotless Tissue Control Devices	Sutures: Plus Antibacterial
Sutures: Absorbable	Sutures: Nonabsorbable				











MICRO-POINT® 	ULTIMA® 
-------------------------------------------------------------------------------------------------------	--------------------------------------------------------------------------------------------------

Reverse Cutting		Spatula				
3/8 Circle	1/2 Circle	1/8 Circle	1/4 Circle 3	1/8 Circle	1/2 Circle	
						
G-6	G-7	CS44-6	CS90-6	CS140-6	CSM-6	CS160-8
						
G-1	G-2		CS100-8	CS140-8	CS160-6	CS175-8
						
G-3					CS175-6	





ULTIMA® 	SPATULA 
--------------------------------------------------------------------------------------------------	--------------------------------------------------------------------------------------------------

Compound Curve	1/4 Circle	3/8 Circle	1/2 Circle	
				
CS-C-6	TG100-8	VAS100-4	TG160-4-3M	TG160-8
				
	CTC-6	TG140-6	TG160-4	TG175-8
				
	CTC-6L	TG140-8T	TG160-6	OPS-5







SABERLOC® 

Conventional Spatula		Spatula			Center Point Spatula	
1/4 Circle	1/2 Circle	1/8 Circle	1/4 Circle	1/2 Circle		
						
S-29	S-28	SM-1	S-14	S-22	S-12	RD-1
						
S-4			S-24	S-2		
Straight Transchamber					Compound Curve	
STC-6					TG6-C	

PRECISION COSMETIC 

Conventional Cosmetic Prime®			
3/8 Circle		1/2 Circle	
			
PC-1	PC-3	PC-5	PC-12

STRAIGHT 

	
SC-1	BN
	
TS	SK-3
	
KS	SKS-3
	
SKS	

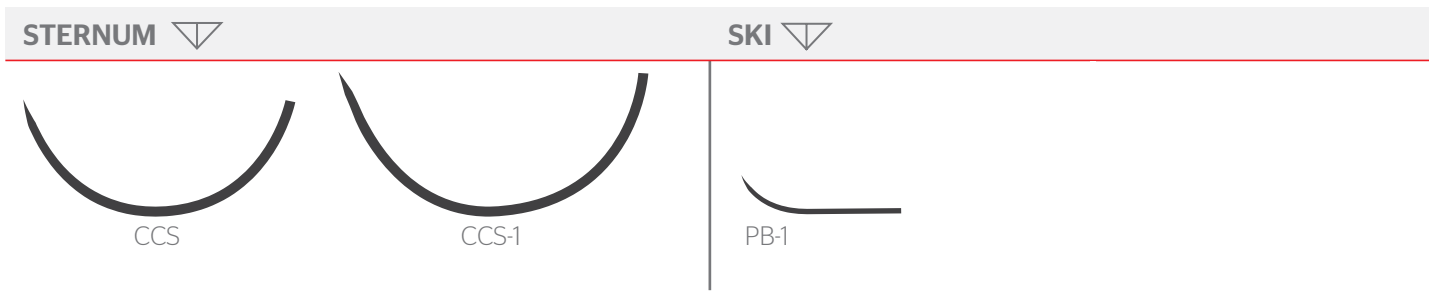

Taper Point

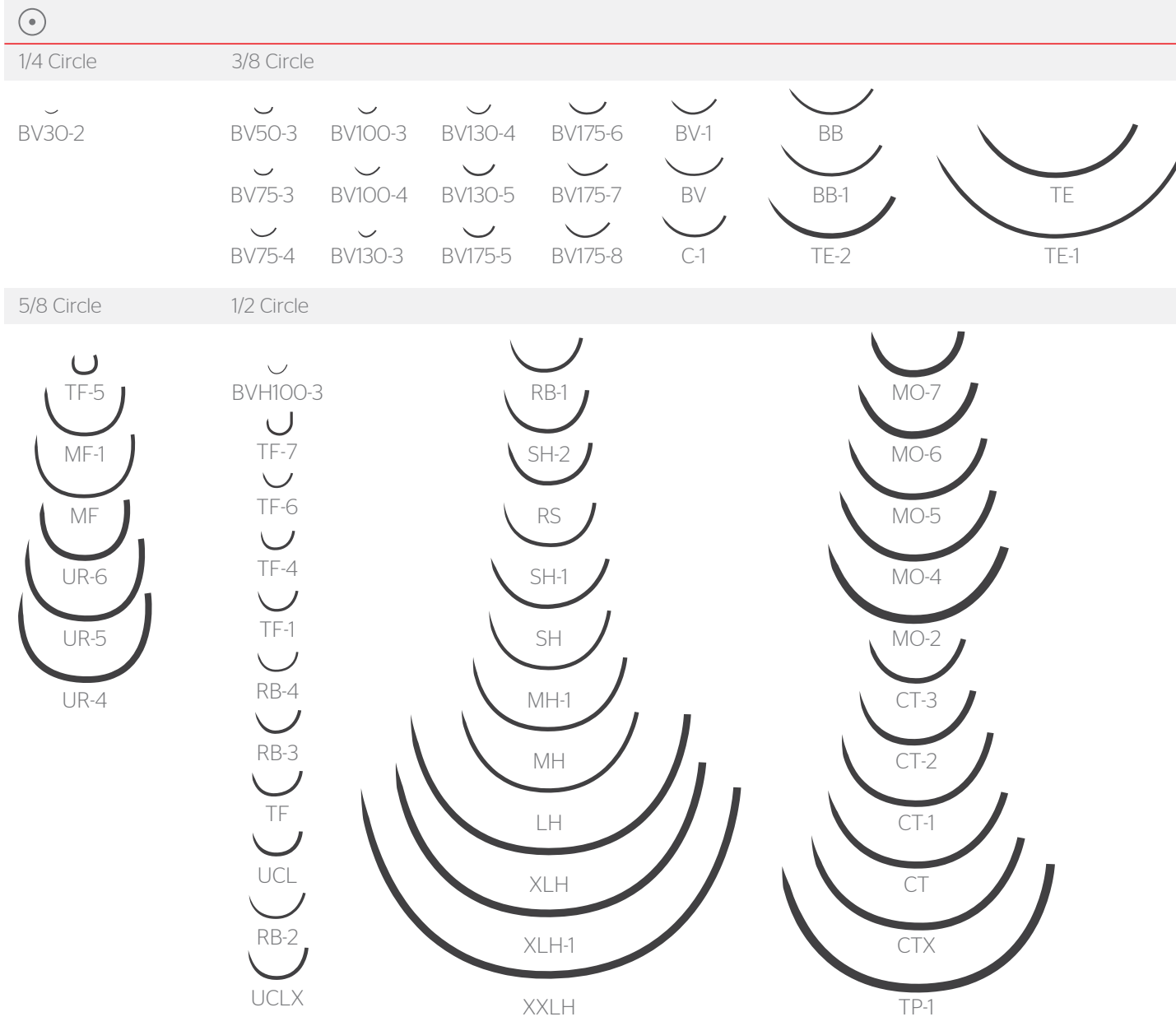

Tapercut®

3/8 Circle		1/4 Circle	Straight	1/2 Circle	
V130-3	CC175-6	V75-3	V-47	V-5	
V130-4	CC175-8	V100-3		V-6	
V130-5	V-18	RV-2		V-7	
CC	V-4	CIF-4		V-34	
CC-1	V-3			V-37	
V-26				V-40	
				V-56	

Trocar

STP-10

Blunt Point

1/2 Circle	Ethiguard®
BP-2	SHB
BP-1	CTB-2
BP	CTB-1
	CTB
	CTXB
	TPB-1

Endoscopy

Taperpoint	Tapercut®
EN-S	EN-5
EN-1	DT-6
EN-2	EN-3
TN	EN-4
	V-38

General Information	Needle Index	True-to-Scale Needle Diagram	Suturing	Knotless Tissue Control Devices	Sutures: Plus Antibacterial
Sutures: Absorbable	Sutures: Nonabsorbable				Suture Chart

Suture Chart



Nonabsorbable Sutures: The Strength You Need for the Choices You Make

	SUTURE BRAND	MATERIAL	SIZES	FREQUENT USES	BSR† PROFILE	
NATURAL	PERMA-HAND® Silk Suture	Braided Black	5, 2 through 7/0	General soft tissue approximation and/or ligation: n Cardiovascular n Ophthalmic n Neurological	Gradual loss of all tensile strength over time	
	SURGICAL STAINLESS STEEL Suture	Monofilament Silver Metallic	7 through 5/0	Soft tissue approximation: n Abdominal n Sternal Closure n Orthopedic procedures including cerclage and tendon repair	Indefinite	
SYNTHETIC	NUROLON® Nylon Suture	Braided Black	1 through 6/0	General soft tissue approximation and/or ligation: n Neurological n Cardiovascular n Ophthalmic	Gradual loss of tensile strength over time	
	ETHILON® Nylon Suture	Monofilament Black / Green / Undyed (Clear)	2 through 11/0	General soft tissue approximation and/or ligation: n Cardiovascular n Ophthalmic n Neurological n Skin Closure	Gradual loss of tensile strength over time	
	MERSILENE® Polyester Fiber Suture	Braided Green / Undyed (white)	1 through 6/0	General soft tissue approximation and/or ligation: n Cardiovascular n Ophthalmic n Neurological	Indefinite	
	ETHIBOND EXCEL® Polyester Suture	Braided Green / Undyed (white)	5, 2 through 7/0	General soft tissue approximation and/or ligation: n Cardiovascular n Ophthalmic n Neurological	Indefinite	
	PROLENE® Polypropylene Suture	Monofilament Blue / Clear	2 through 10/0	General soft tissue approximation and/or ligation: n Cardiovascular n Ophthalmic n Neurological	Indefinite	
	PRONOVA® Poly (hexafluoropropylene-VDF) Suture	Monofilament Blue	2/0 through 8/0	General soft tissue approximation and/or ligation: n Cardiovascular n Ophthalmic n Neurological	Indefinite	

† BSR=breaking strength retention (tensile strength of suture in vivo)

Nonabsorbable Sutures: The Strength You Need for the Choices You Make

	SUTURE BRAND	MATERIAL	SIZES	FREQUENT USES	BSR† PROFILE	
NATURAL	PERMA-HAND® Silk Suture	Braided Black	5, 2 through 7/0	General soft tissue approximation and/or ligation: n Cardiovascular n Ophthalmic n Neurological	Gradual loss of all tensile strength over time	
	SURGICAL STAINLESS STEEL Suture	Monofilament Silver Metallic	7 through 5/0	Soft tissue approximation: n Abdominal n Sternal Closure n Orthopedic procedures including cerclage and tendon repair	Indefinite	
SYNTHETIC	NUROLON® Nylon Suture	Braided Black	1 through 6/0	General soft tissue approximation and/or ligation: n Neurological n Cardiovascular n Ophthalmic	Gradual loss of tensile strength over time	
	ETHILON® Nylon Suture	Monofilament Black / Green / Undyed (Clear)	2 through 11/0	General soft tissue approximation and/or ligation: n Cardiovascular n Ophthalmic n Neurological n Skin Closure	Gradual loss of tensile strength over time	
	MERSILENE® Polyester Fiber Suture	Braided Green / Undyed (white)	1 through 6/0	General soft tissue approximation and/or ligation: n Cardiovascular n Ophthalmic n Neurological	Indefinite	
	ETHIBOND EXCEL® Polyester Suture	Braided Green / Undyed (white)	5, 2 through 7/0	General soft tissue approximation and/or ligation: n Cardiovascular n Ophthalmic n Neurological	Indefinite	
	PROLENE® Polypropylene Suture	Monofilament Blue / Clear	2 through 10/0	General soft tissue approximation and/or ligation: n Cardiovascular n Ophthalmic n Neurological	Indefinite	
	PRONOVA® Poly (hexafluoropropylene-VDF) Suture	Monofilament Blue	2/0 through 8/0	General soft tissue approximation and/or ligation: n Cardiovascular n Ophthalmic n Neurological	Indefinite	

† BSR=breaking strength retention (tensile strength of suture in vivo)

General Information	Needle Index	True-to-Scale Needle Diagram	Suturing	Knotless Tissue Control Devices	Sutures: Plus Antibacterial
Sutures: Absorbable	Sutures: Nonabsorbable				

Knotless Tissue Control Devices



General Information	Needle Index	True-to-Scale Needle Diagram	Suturing	Knotless Tissue Control Devices	Sutures: Plus Antibacterial
Sutures: Absorbable	Sutures: Nonabsorbable				

STRATAFIX™ Knotless Tissue Control Device

STRATAFIX™ Symmetric PDS™ Plus Devices are the only knotless tissue control device that provides strong, secure closure appropriate for high-tension areas such as fascia.

STRATAFIX™ Spiral Devices provide smooth tissue passage and a secure hold that helps control tension and achieve excellent tissue approximation.

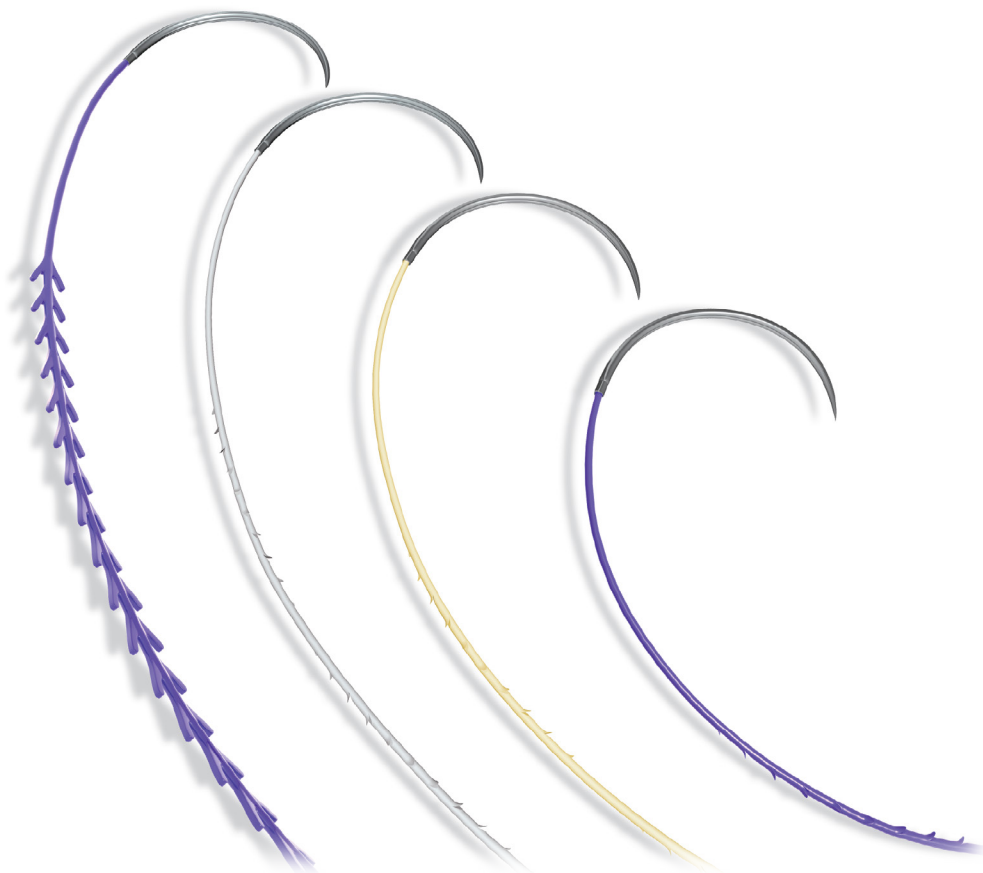



General Information	Needle Index	True-to-Scale Needle Diagram	Suturing	Knotless Tissue Control Devices	Sutures: Plus Antibacterial
Sutures: Absorbable	Sutures: Nonabsorbable				

STRATAFIX™ Knotless Tissue Control Device



STRATAFIX™ Spiral PDO Knotless Tissue Control Device - **Bidirectional dyed**

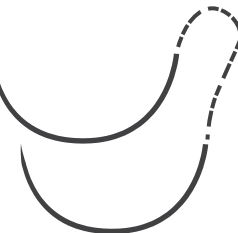
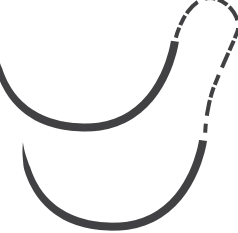

Taperpoint 					
Needle	Suture USP	Color	Length	EA/BX	Product Code
 CT-3 22mm 1/2 Circle	0	Violet	5.5"/14cm X 5.5"/14cm	12	SXPD2B404
 SH 22mm 1/2 Circle	2-0	Violet	3.9"/10cm X 3.9"/10cm	12	SXPD2B413
	2-0	Violet	5.5"/14cm X 5.5"/14cm	12	SXPD2B414
 MH 36mm 1/2 Circle	2-0	Violet	3"/7cm X 3"/7cm	12	SXPD2B406
	2-0	Violet	5.5"/14cm X 5.5"/14cm	12	SXPD2B407
	2-0	Violet	9.4"/24cm X 9.4"/24cm	12	SXPD2B408
	2-0	Violet	14.2"/36cm X 14.2"/36cm	12	SXPD2B412
	0	Violet	5.5"/14cm X 5.5"/14cm	12	SXPD2B409
	0	Violet	9.4"/24cm X 9.4"/24cm	12	SXPD2B410
 CT-1 36mm 1/2 Circle	1	Violet	5.5"/14cm X 5.5"/14cm	12	SXPD2B401
	1	Violet	9.4"/24cm X 9.4"/24cm	12	SXPD2B402
	1	Violet	11.8"/30cm X 11.8"/30cm	12	SXPD2B403



General Information	Needle Index	True-to-Scale Needle Diagram	Suturing	Knotless Tissue Control Devices	Sutures: Plus Antibacterial
Sutures: Absorbable	Sutures: Nonabsorbable				





STRATAFIX™ Knotless Tissue Control Device

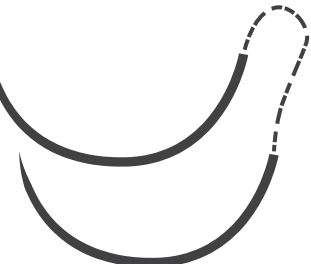

STRATAFIX™ Spiral PDO Knotless Tissue Control Device - **Bidirectional dyed**



Taperpoint 					
Needle	Suture USP	Color	Length	EA/BX	Product Code
 <p>MO-4 36mm 1/2 Circle</p>	1	Violet	14.2"/36cm X 14.2"/36cm	12	SXPD2B400
 <p>CTX 48mm 1/2 Circle</p>	1	Violet	14.2"/36cm X 14.2"/36cm	12	SXPD2B405

Tapercut 					
Needle	Suture USP	Color	Length	EA/BX	Product Code
 <p>V-4 17mm 3/8 Circle</p>	4-0	Violet	9.4"/24cm X 9.4"/24cm	12	SXPD2B426
 <p>V-26 26mm 3/8 Circle</p>	4-0	Violet	5.5"/14cm X 5.5"/14cm	12	SXPD2B425
 <p>V-26 26mm 3/8 Circle</p>	4-0	Violet	9.4"/24cm X 9.4"/24cm	12	SXPD2B424





General Information	Needle Index	True-to-Scale Needle Diagram	Suturing	Knotless Tissue Control Devices	Sutures: Plus Antibacterial
Sutures: Absorbable	Sutures: Nonabsorbable				

STRATAFIX™ Knotless Tissue Control Device



STRATAFIX™ Spiral PDO Knotless Tissue Control Device - **Bidirectional dyed**



Cutting Edge Reverse ▾					
Needle	Suture USP	Color	Length	EA/BX	Product Code
 <p>FS-2 19mm 3/8 Circle</p>	5-0	Violet	3"/7cm X 3"/7cm	12	SXPDP2B421
	4-0	Violet	3"/7cm X 3"/7cm	12	SXPDP2B422
	4-0	Violet	5.5"/14cm X 5.5"/14cm	12	SXPDP2B423
 <p>FS 26mm 3/8 Circle</p>	3-0	Violet	5.5"/14cm X 5.5"/14cm	12	SXPDP2B417
	3-0	Violet	9.4"/24cm X 9.4"/24cm	12	SXPDP2B419
	2-0	Violet	5.5"/14cm X 5.5"/14cm	12	SXPDP2B418
	2-0	Violet	9.4"/24cm X 9.4"/24cm	12	SXPDP2B420
 <p>CP-2 26mm 1/2 Circle</p>	0	Violet	9.4"/24cm X 9.4"/24cm	12	SXPDP2B415
	1	Violet	9.4"/24cm X 9.4"/24cm	12	SXPDP2B416
 <p>OS-6 36mm 1/2 Circle</p>	1	Violet	9.4"/24cm X 9.4"/24cm	12	SXPDP2B200
	1	Violet	11.8"/30cm X 11.8"/30cm	12	SXPDP2B201
 <p>OS-8 40mm 1/2 Circle</p>	1	Violet	14.2"/36cm X 14.2"/36cm	12	SXPDP2B202



General Information	Needle Index	True-to-Scale Needle Diagram	Suturing	Knotless Tissue Control Devices	Sutures: Plus Antibacterial
Sutures: Absorbable	Sutures: Nonabsorbable				



STRATAFIX™ Knotless Tissue Control Device



STRATAFIX™ Spiral PGA-PCL
Knotless Tissue Control Device
Bidirectional undyed

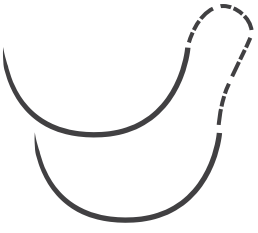

Taperpoint 					
Needle	Suture USP	Color	Length	EA/BX	Product Code
 RB-1 17mm 1/2 Circle	4-0	Clear	6.3"/16cm X 6.3"/16cm	12	SXMD2B403
	3-0	Clear	6.3"/16cm X 6.3"/16cm	12	SXMD2B402
 MH 36mm 1/2 Circle	2-0	Clear	5.5"/14cm X 5.5"/14cm	12	SXMD2B400
	2-0	Clear	14.2"/36cm X 14.2"/36cm	12	SXMD2B401

Cutting Edge Reverse 					
Needle	Suture USP	Color	Length	EA/BX	Product Code
 FS-2 19mm 3/8 Circle	4-0	Clear	3"/7cm X 3"/7cm	12	SXMD2B405
	4-0	Clear	5.5"/14cm X 5.5"/14cm	12	SXMD2B407
	4-0	Clear	11.8"/30cm X 11.8"/30cm	12	SXMD2B409
	3-0	Clear	3"/7cm X 3"/7cm	12	SXMD2B404
	3-0	Clear	5.5"/14cm X 5.5"/14cm	12	SXMD2B406
	3-0	Clear	11.8"/30cm X 11.8"/30cm	12	SXMD2B408
 FS-1 24mm 3/8 Circle	4-0	Clear	11.8"/30cm X 11.8"/30cm	12	SXMD2B150
	3-0	Clear	11.8"/30cm X 11.8"/30cm	12	SXMD2B410

General Information	Needle Index	True-to-Scale Needle Diagram	Suturing	Knotless Tissue Control Devices	Sutures: Plus Antibacterial
Sutures: Absorbable	Sutures: Nonabsorbable				

STRATAFIX™ Knotless Tissue Control Device

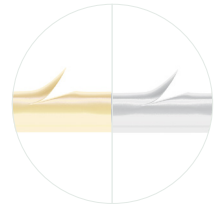

STRATAFIX™ Spiral PGA-PCL
Knotless Tissue Control Device
Bidirectional undyed



Cutting Edge Reverse ▾					
Needle	Suture USP	Color	Length	EA/BX	Product Code
 FS 26mm 3/8 Circle	4-0	Clear	11.8"/30cm X 11.8"/30cm	12	SXMD2B413
	3-0	Clear	5.5"/14cm X 5.5"/14cm	12	SXMD2B411
	3-0	Clear	11.8"/30cm X 11.8"/30cm	12	SXMD2B412
 CP-2 26mm 1/2 Circle	2-0	Clear	5.5"/14cm X 5.5"/14cm	12	SXMD2B414

STRATAFIX™ Spiral Polypropylene
Knotless Tissue Control Device
Bidirectional undyed

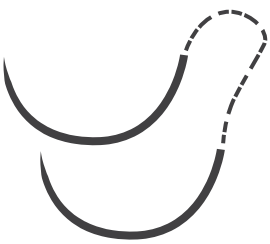

Taperpoint ⊙					
Needle	Suture USP	Color	Length	EA/BX	Product Code
 CT-3 22mm 1/2 Circle	0	Clear	5.5"/14cm X 5.5"/14cm	12	SXPL2B401
 CT-1 36mm 1/2 Circle	1	Clear	9.4"/24cm X 9.4"/24cm	12	SXPL2B400







General Information	Needle Index	True-to-Scale Needle Diagram	Suturing	Knotless Tissue Control Devices	Sutures: Plus Antibacterial
Sutures: Absorbable	Sutures: Nonabsorbable				

STRATAFIX™ Knotless Tissue Control Device



STRATAFIX™ Spiral MONOCRYL®
Plus Knotless Tissue
Control Device
Unidirectional undyed



Taperpoint 					
Needle	Suture USP	Color	Length	EA/BX	Product Code
 RB-1 17mm 1/2 Circle	4-0	Undyed	6"/15cm	12	SXMP1B434
	4-0	Undyed	12"/30cm	12	SXMP1B435
	3-0	Undyed	6"/15cm	12	SXMP1B424
	3-0	Undyed	12"/30cm	12	SXMP1B425
 CT-2 26mm 1/2 Circle	2-0	Undyed	6"/15cm	12	SXMP1B415
	2-0	Undyed	12"/30cm	12	SXMP1B416
	2-0	Undyed	18"/45cm	12	SXMP1B417
 SH 26mm 1/2 Circle	4-0	Undyed	27"/70cm	12	SXMP1B437
	3-0	Undyed	9"/23cm	12	SXMP1B427
	3-0	Undyed	27"/70cm	12	SXMP1B428
	2-0	Undyed	6"/15cm	12	SXMP1B408
	2-0	Undyed	9"/23cm	12	SXMP1B409
	2-0	Undyed	12"/30cm	12	SXMP1B410
 CT-1 36mm 1/2 Circle	3-0	Undyed	18"/45cm	12	SXMP1B429
	2-0	Undyed	6"/15cm	12	SXMP1B411
	2-0	Undyed	12"/30cm	12	SXMP1B412
	2-0	Undyed	18"/45cm	12	SXMP1B413
	2-0	Undyed	27"/70cm	12	SXMP1B414
 ST-4 19mm Straight	3-0	Undyed	12"/30cm	12	SXMP1B433

General Information	Needle Index	True-to-Scale Needle Diagram	Suturing	Knotless Tissue Control Devices	Sutures: Plus Antibacterial
Sutures: Absorbable	Sutures: Nonabsorbable				



STRATAFIX™ Knotless Tissue Control Device



STRATAFIX™ Spiral MONOCRYL®
Plus Knotless Tissue
Control Device
Unidirectional undyed



Cutting Edge Reverse ▾					
Needle	Suture USP	Color	Length	EA/BX	Product Code
 PSL 30mm 3/8 Circle	2-0	Undyed	27"/70cm	12	SXMP1B421
 CP-2 26mm 1/2 Circle	2-0	Undyed	12"/30cm	12	SXMP1B420
 CP-1 36mm 1/2 Circle	2-0	Undyed	27"/70cm	12	SXMP1B419



Prime Reverse Cutting ▾					
Needle	Suture USP	Color	Length	EA/BX	Product Code
 PS-2 19mm 3/8 Circle	4-0	Undyed	12"/30cm	12	SXMP1B117
	4-0	Undyed	18"/45cm	12	SXMP1B118
	4-0	Undyed	27"/70cm	12	SXMP1B119
	3-0	Undyed	6"/15cm	12	SXMP1B105
	3-0	Undyed	12"/30cm	12	SXMP1B106
	3-0	Undyed	18"/45cm	12	SXMP1B107
	3-0	Undyed	24"/60cm	12	SXMP1B108
	3-0	Undyed	27"/70cm	12	SXMP1B109
 PS-1 24mm 3/8 Circle	4-0	Undyed	12"/30cm	12	SXMP1B114
	4-0	Undyed	18"/45cm	12	SXMP1B115
	4-0	Undyed	27"/70cm	12	SXMP1B116
	3-0	Undyed	12"/30cm	12	SXMP1B101
	3-0	Undyed	18"/45cm	12	SXMP1B102
	3-0	Undyed	24"/60cm	12	SXMP1B103
	3-0	Undyed	27"/70cm	12	SXMP1B104

STRATAFIX™ Knotless Tissue Control Device







STRATAFIX™ Spiral MONOCRYL®
Plus Knotless Tissue
Control Device
Unidirectional undyed



Prime Reverse Cutting 					
Needle	Suture USP	Color	Length	EA/BX	Product Code
 PS 26mm 3/8 Circle	3-0	Undyed	12"/30cm	12	SXMP1B110
	3-0	Undyed	18"/45cm	12	SXMP1B111
	3-0	Undyed	27"/70cm	12	SXMP1B113
 PS-4 16mm 1/2 Circle	4-0	Undyed	18"/45cm	12	SXMP1B120

STRATAFIX™ Spiral PDS™ Plus
Knotless Tissue Control Device
Unidirectional dyed



Taperpoint 					
Needle	Suture USP	Color	Length	EA/BX	Product Code
 RB-1 17mm 1/2 Circle	4-0	Violet	6"/15cm	12	SXPP1B427
	4-0	Violet	12"/30cm	12	SXPP1B428
	3-0	Violet	6"/15cm	12	SXPP1B422
 CT-2 26mm 1/2 Circle	3-0	Violet	27"/70cm	12	SXPP1B425
	2-0	Violet	6"/15cm	12	SXPP1B413
	2-0	Violet	27"/70cm	12	SXPP1B414
	0	Violet	12"/30cm	12	SXPP1B405
 SH 26mm 1/2 Circle	4-0	Violet	27"/70cm	12	SXPP1B426
	3-0	Violet	6"/15cm	12	SXPP1B420
	3-0	Violet	27"/70cm	12	SXPP1B421
	2-0	Violet	6"/15cm	12	SXPP1B415
	2-0	Violet	12"/30cm	12	SXPP1B416
	2-0	Violet	27"/70cm	12	SXPP1B417









General Information	Needle Index	True-to-Scale Needle Diagram	Suturing	Knotless Tissue Control Devices	Sutures: Plus Antibacterial
Sutures: Absorbable	Sutures: Nonabsorbable				

STRATAFIX™ Knotless Tissue Control Device



STRATAFIX™ Spiral PDS™ Plus
Knotless Tissue Control Device
Unidirectional dyed



Taperpoint 					
Needle	Suture USP	Color	Length	EA/BX	Product Code
 SH-1 22mm 1/2 Circle	4-0	Violet	9"/22cm	12	SXPP1B454
	3-0	Violet	9"/22cm	12	SXPP1B453
 CT-1 36mm 1/2 Circle	2-0	Violet	6"/15cm	12	SXPP1B409
	2-0	Violet	9"/22cm	12	SXPP1B456
	2-0	Violet	12"/30cm	12	SXPP1B410
	2-0	Violet	18"/45cm	12	SXPP1B411
	2-0	Violet	27"/70cm	12	SXPP1B412
	0	Violet	6"/15cm	12	SXPP1B406
	0	Violet	9"/22cm	12	SXPP1B455
	0	Violet	12"/30cm	12	SXPP1B450
	0	Violet	18"/45cm	12	SXPP1B407
	0	Violet	27"/70cm	12	SXPP1B408
	1	Violet	12"/30cm	12	SXPP1B429
	1	Violet	18"/45cm	12	SXPP1B430
1	Violet	27"/70cm	12	SXPP1B431	
 MO-4 36mm 1/2 Circle	1	Violet	27"/70cm	12	SXPP1B205
 CTX 48mm 1/2 Circle	1	Violet	27"/70cm	12	SXPP1B401
	1	Violet	36"/90cm	12	SXPP1B402
 UR-6 26mm 5/8 Circle	2-0	Violet	12"/30cm	12	SXPP1B419
 EN-S 19mm Ski	0	Violet	12"/30cm	12	SXPP1B452
 ST-4 19mm Straight	3-0	Violet	6"/15cm	12	SXPP1B424



General Information	Needle Index	True-to-Scale Needle Diagram	Suturing	Knotless Tissue Control Devices	Sutures: Plus Antibacterial
Sutures: Absorbable	Sutures: Nonabsorbable				

STRATAFIX™ Knotless Tissue Control Device



STRATAFIX™ Spiral PDS™ Plus
Knotless Tissue Control Device
Unidirectional dyed



Tapercut 					
Needle	Suture USP	Color	Length	EA/BX	Product Code
 V-7 26mm 1/2 Circle	2-0	Violet	12"/30cm	12	SXPP1B418
 V-34 36mm 1/2 Circle	2-0	Violet	9"/22cm	12	SXPP1B458
	0	Violet	9"/22cm	12	SXPP1B457
	0	Violet	12"/30cm	12	SXPP1B404

Cutting Edge Reverse 					
Needle	Suture USP	Color	Length	EA/BX	Product Code
 FS 26mm 3/8 Circle	2-0	Violet	18"/45cm	12	SXPP1B101
	2-0	Violet	27"/70cm	12	SXPP1B102
 CP-2 26mm 1/2 Circle	0	Violet	18"/45cm	12	SXPP1B202
	1	Violet	18"/45cm	12	SXPP1B403
 OS-6 36mm 1/2 Circle	1	Violet	18"/45cm	12	SXPP1B201
	1	Violet	27"/70cm	12	SXPP1B203
 OS-8 40mm 1/2 Circle	1	Violet	27"/70cm	12	SXPP1B204

STRATAFIX™ Knotless Tissue Control Device

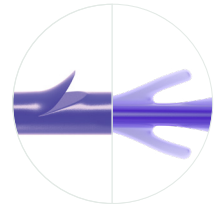



STRATAFIX™ Spiral PDS™ Plus Knotless Tissue Control Device
Unidirectional dyed



Prime Reverse Cutting 					
Needle	Suture USP	Color	Length	EA/BX	Product Code
 PS-2 19mm 3/8 Circle	4-0	Violet	6"/15cm	12	SXPP1B111
	4-0	Violet	12"/30cm	12	SXPP1B112
	4-0	Violet	18"/45cm	12	SXPP1B113
	4-0	Violet	27"/70cm	12	SXPP1B114
	3-0	Violet	6"/15cm	12	SXPP1B103
	3-0	Violet	12"/30cm	12	SXPP1B104
	3-0	Violet	18"/45cm	12	SXPP1B105
	3-0	Violet	27"/70cm	12	SXPP1B106
 PS-1 24mm 3/8 Circle	4-0	Violet	18"/45cm	12	SXPP1B116
	4-0	Violet	23"/60cm	12	SXPP1B117
	3-0	Violet	27"/70cm	12	SXPP1B110
 PS 26mm 3/8 Circle	4-0	Violet	18"/45cm	12	SXPP1B118
	3-0	Violet	12"/30cm	12	SXPP1B107
	3-0	Violet	18"/45cm	12	SXPP1B108
	3-0	Violet	27"/70cm	12	SXPP1B109
 X-1 22mm 3/8 Circle	3-0	Violet	27"/70cm	12	SXPP1B120

STRATAFIX™ Symmetric PDS™ Plus Knotless Tissue Control Device
Unidirectional dyed



Blunt Point Ethiguard 					
Needle	Suture USP	Color	Length	EA/BX	Product Code
 CTB-1 36mm 1/2 Circle	1	Violet	18"/45cm	12	SXPP1A301
 CTXB 48mm 1/2 Circle	0	Violet	18"/45cm	12	SXPP1A302
	1	Violet	18"/45cm	12	SXPP1A300

General Information	Needle Index	True-to-Scale Needle Diagram	Suturing	Knotless Tissue Control Devices	Sutures: Plus Antibacterial
Sutures: Absorbable	Sutures: Nonabsorbable				

STRATAFIX™ Knotless Tissue Control Device

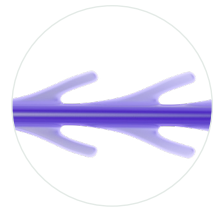

STRATAFIX™ Symmetric PDS™ Plus
Knotless Tissue Control Device
Unidirectional dyed



Taperpoint					
Needle	Suture USP	Color	Length	EA/BX	Product Code
 CT-2 26mm 1/2 Circle	2-0	Violet	18"/45cm	12	SXPP1A408
	0	Violet	18"/45cm	12	SXPP1A407
 SH 26mm 1/2 Circle	3-0	Violet	18"/45cm	12	SXPP1A410
	2-0	Violet	18"/45cm	12	SXPP1A409
 CT-1 36mm 1/2 Circle	2-0	Violet	18"/45cm	12	SXPP1A403
	0	Violet	18"/45cm	12	SXPP1A401
	1	Violet	18"/45cm	12	SXPP1A404
 CT 40mm 1/2 Circle	0	Violet	18"/45cm	12	SXPP1A406
	1	Violet	18"/45cm	12	SXPP1A405
 CTX 48mm 1/2 Circle	0	Violet	18"/45cm	12	SXPP1A402
	1	Violet	18"/45cm	12	SXPP1A400

Cutting Edge Reverse					
Needle	Suture USP	Color	Length	EA/BX	Product Code
 OS-6 36mm 1/2 Circle	0	Violet	18"/45cm	12	SXPP1A200
	1	Violet	18"/45cm	12	SXPP1A201

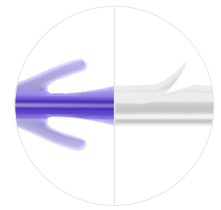

General Information	Needle Index	True-to-Scale Needle Diagram	Suturing	Knotless Tissue Control Devices	Sutures: Plus Antibacterial
Sutures: Absorbable	Sutures: Nonabsorbable				

STRATAFIX™ Knotless Tissue Control Device





STRATAFIX™ Symmetric PDS™ Plus
Knotless Tissue Control Device
Unidirectional dyed



Prime Reverse Cutting 					
Needle	Suture USP	Color	Length	EA/BX	Product Code
 PS-2 19mm 3/8 Circle	3-0	Violet	18"/45cm	12	SXPP1A101
 PS-1 24mm 3/8 Circle	3-0	Violet	18"/45cm	12	SXPP1A100

STRATAFIX™ Spiral
Polypropylene Knotless
Tissue Control Device
Unidirectional undyed



Taperpoint 					
Needle	Suture USP	Color	Length	EA/BX	Product Code
 SH-1 22mm 1/2 Circle	2-0	Clear	11.8"/30cm	12	SXPL1B400

General Information	Needle Index	True-to-Scale Needle Diagram	Suturing	Knotless Tissue Control Devices	Sutures: Plus Antibacterial
Sutures: Absorbable	Sutures: Nonabsorbable				

Sutures: Plus Antibacterial



General Information	Needle Index	True-to-Scale Needle Diagram	Suturing	Knotless Tissue Control Devices	Sutures: Plus Antibacterial
Sutures: Absorbable	Sutures: Nonabsorbable				

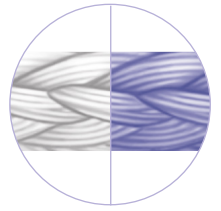

Coated VICRYL Plus Antibacterial (polyglactin 910) Suture





Coated VICRYL Plus Suture is indicated for use in general soft tissue approximation and/or ligation, except for ophthalmic, cardiovascular and neurological tissues.

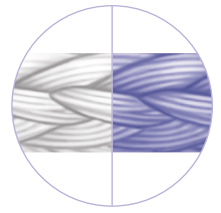

General Information	Needle Index	True-to-Scale Needle Diagram	Suturing	Knotless Tissue Control Devices	Sutures: Plus Antibacterial
Sutures: Absorbable	Sutures: Nonabsorbable				

Coated VICRYL® Plus Antibacterial (polyglactin 910) Suture







Blunt Point ETHIGUARD 						
Needle	Suture USP	Color	Length	EA/BX	Special	Product Code
 CTB-2 26mm 1/2 Circle	2-0	Undyed	1 X 27"/70cm	36		<u>VCPB269H</u>
	2-0	Violet	8 X 18"/45cm	12	CR	<u>VCPB726D*</u>
	0	Violet	8 X 18"/45cm	12	CR	<u>VCPB727D*</u>
 SHB 26mm 1/2 Circle	3-0	Undyed	1 X 27"/70cm	36		<u>VCPB416H</u>
	3-0	Undyed	8 X 18"/45cm	12	CR	<u>VCPB864D*</u>
	3-0	Violet	8 X 18"/45cm	12	CR	<u>VCPB774D*</u>
	2-0	Undyed	1 X 27"/70cm	36		<u>VCPB417H</u>
 CTB-1 36mm 1/2 Circle	3-0	Undyed	1 X 36"/90cm	36		<u>VCPB944H</u>
	2-0	Undyed	8 X 18"/45cm	12	CR	<u>VCPB839D*</u>
	2-0	Undyed	1 X 27"/70cm	36		<u>VCPB259H</u>
	2-0	Undyed	1 X 36"/90cm	36		<u>VCPB945H</u>
	2-0	Violet	8 X 18"/45cm	12	CR	<u>VCPB739D*</u>
	0	Undyed	8 X 18"/45cm	12	CR	<u>VCPB840D*</u>
	0	Violet	8 X 18"/45cm	12	CR	<u>VCPB740D*</u>
	0	Undyed	1 X 27"/70cm	36		<u>VCPB260H</u>
	0	Undyed	8 X 27"/70cm	12	CR	<u>VCPB41D*</u>
	0	Violet	1 X 27"/70cm	36		<u>VCPB340H</u>
	0	Violet	8 X 27"/70cm	12	CR	<u>VCPB31D*</u>
	0	Undyed	1 X 36"/90cm	36		<u>VCPB946H</u>
	1	Undyed	8 X 18"/45cm	12	CR	<u>VCPB841D*</u>
	1	Violet	8 X 18"/45cm	12	CR	<u>VCPB741D*</u>
	1	Violet	1 X 27"/70cm	36		<u>VCPB341H</u>
1	Undyed	1 X 36"/90cm	36		<u>VCPB947H</u>	

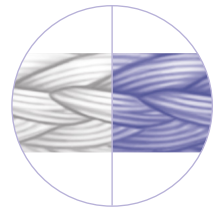

*Safety organizer tray **CR** CONTROL RELEASE Needle Suture

General Information	Needle Index	True-to-Scale Needle Diagram	Suturing	Knotless Tissue Control Devices	Sutures: Plus Antibacterial
Sutures: Absorbable	Sutures: Nonabsorbable				

Coated VICRYL® Plus Antibacterial (polyglactin 910) Suture







Blunt Point ETHIGUARD						
Needle	Suture USP	Color	Length	EA/BX	Special	Product Code
 CTB 40mm 1/2 Circle	0	Undyed	1 X 36"/90cm	36		VCPB958H
 CTXB 48mm 1/2 Circle	0	Undyed	8 X 18"/45cm	12	CR	VCPB724D*
	0	Undyed	1 X 36"/90cm	36		VCPB978H
	1	Undyed	8 X 18"/45cm	12	CR	VCPB725D*
	1	Violet	8 X 18"/45cm	12	CR	VCPB765D*
	1	Undyed	1 X 36"/90cm	36		VCPB977H
 TPB-1 65mm 1/2 Circle	1	Violet	4 X 27"/70cm	12		VCPB650G

Taperpoint						
Needle	Suture USP	Color	Length	EA/BX	Special	Product Code
 TF 13mm 1/2 Circle	4-0	Violet	8 X 18"/45cm	12	CR	VCP743D*
 RB-2 13mm 1/2 Circle	5-0	Undyed	1 X 27"/70cm	36		VCP433H
	4-0	Undyed	1 X 27"/70cm	36		VCP434H

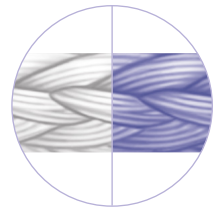
*Safety organizer tray CONTROL RELEASE Needle Suture



Coated VICRYL® Plus Antibacterial (polyglactin 910) Suture

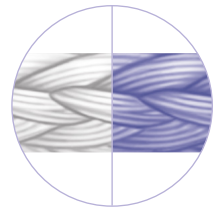

Taperpoint 						
Needle	Suture USP	Color	Length	EA/BX	Special	Product Code
 RB-1 17mm 1/2 Circle	5-0	Undyed	1 X 27"/70cm	36		VCP213H
	5-0	Violet	1 X 27"/70cm	36		VCP303H
	4-0	Undyed	8 X 18"/45cm	12	CR	VCP714D*
	4-0	Undyed	1 X 27"/70cm	36		VCP214H
	4-0	Violet	1 X 27"/70cm	36		VCP304H
	3-0	Violet	8 X 18"/45cm	12	CR	VCP713D*
	3-0	Undyed	1 X 27"/70cm	36		VCP215H
	3-0	Violet	1 X 27"/70cm	36		VCP305H
	2-0	Violet	1 X 27"/70cm	36		VCP306H
 SH-1 22mm 1/2 Circle	4-0	Violet	8 X 18"/45cm	12	CR	VCP771D*
	4-0	Undyed	1 X 27"/70cm	36		VCP218H
	4-0	Violet	1 X 27"/70cm	36		VCP310H
	3-0	Violet	8 X 18"/45cm	12	CR	VCP772D*
	3-0	Undyed	1 X 27"/70cm	36		VCP219H
	3-0	Violet	1 X 27"/70cm	36		VCP311H
 CT-3 22mm 1/2 Circle	3-0	Violet	1 X 27"/70cm	36		VCP327H
	2-0	Violet	1 X 27"/70cm	36		VCP328H
	0	Violet	1 X 27"/70cm	36		VCP329H

Coated VICRYL® Plus Antibacterial (polyglactin 910) Suture





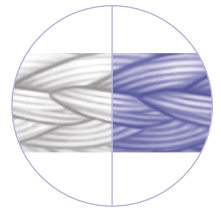

Taperpoint 						
Needle	Suture USP	Color	Length	EA/BX	Special	Product Code
 <p>CT-2 26mm 1/2 Circle</p>	3-0	Undyed	1 X 27"/70cm	36		VCP232H
	3-0	Violet	1 X 27"/70cm	36		VCP332H
	2-0	Violet	8 X 18"/45cm	12	CR	VCP726D*
	2-0	Undyed	1 X 27"/70cm	36		VCP269H
	2-0	Violet	1 X 27"/70cm	36		VCP333H
	0	Violet	8 X 18"/45cm	12	CR	VCP727D*
	0	Undyed	1 X 27"/70cm	36		VCP270H
	0	Violet	1 X 27"/70cm	36		VCP334H
	1	Violet	1 X 27"/70cm	36		VCP335H
 <p>SH 26mm 1/2 Circle</p>	4-0	Violet	8 X 18"/45cm	12	CR	VCP773D*
	4-0	Undyed	1 X 27"/70cm	36		VCP415H
	4-0	Violet	1 X 27"/70cm	36		VCP315H
	3-0	Undyed	8 X 18"/45cm	12	CR	VCP864D*
	3-0	Violet	8 X 18"/45cm	12	CR	VCP774D*
	3-0	Undyed	1 X 27"/70cm	36		VCP416H
	3-0	Violet	1 X 27"/70cm	36		VCP316H
	3-0	Violet	8 X 27"/70cm	12	CR	VCP784D*
	2-0	Violet	8 X 18"/45cm	12	CR	VCP775D*
	2-0	Undyed	1 X 27"/70cm	36		VCP417H
	2-0	Violet	1 X 27"/70cm	36		VCP317H
	2-0	Violet	8 X 27"/70cm	12	CR	VCP785D*
	0	Undyed	1 X 27"/70cm	36		VCP418H

General Information	Needle Index	True-to-Scale Needle Diagram	Suturing	Knotless Tissue Control Devices	Sutures: Plus Antibacterial
Sutures: Absorbable	Sutures: Nonabsorbable				

Coated VICRYL® Plus Antibacterial (polyglactin 910) Suture





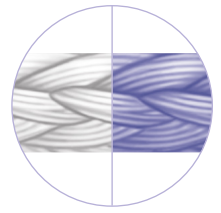

Taperpoint						
Needle	Suture USP	Color	Length	EA/BX	Special	Product Code
 SH 26mm 1/2 Circle	3-0	Violet	1 X 36"/90cm	36		<u>VCP527H</u>
 MO-6 26mm 1/2 Circle	2-0	Violet	8 X 18"/45cm	12	CR	<u>VCP789D*</u>
 MO-5 31mm 1/2 Circle	0	Violet	8 X 18"/45cm	12	CR	<u>VCP801D*</u>
	0	Violet	8 X 27"/70cm	12	CR	<u>VCPP81D*</u>
	1	Violet	8 X 27"/70cm	12	CR	<u>VCPP80D*</u>
 CT-1 36mm 1/2 Circle	3-0	Undyed	8 X 18"/45cm	12	CR	<u>VCP838D*</u>
	3-0	Violet	8 X 18"/45cm	12	CR	<u>VCP738D*</u>
	3-0	Undyed	1 X 27"/70cm	36		<u>VCP258H</u>
	3-0	Violet	1 X 27"/70cm	36		<u>VCP338H</u>
	3-0	Undyed	1 X 36"/90cm	36		<u>VCP944H</u>
	3-0	Violet	1 X 36"/90cm	36		<u>VCP344H</u>
	2-0	Undyed	8 X 18"/45cm	12	CR	<u>VCP839D*</u>
	2-0	Violet	8 X 18"/45cm	12	CR	<u>VCP739D*</u>
	2-0	Undyed	1 X 27"/70cm	36		<u>VCP259H</u>
	2-0	Undyed	8 X 27"/70cm	12	CR	<u>VCPP42D*</u>
	2-0	Violet	1 X 27"/70cm	36		<u>VCP339H</u>
	2-0	Undyed	1 X 36"/90cm	36		<u>VCP945H</u>
2-0	Violet	1 X 36"/90cm	36		<u>VCP345H</u>	

*Safety organizer tray CONTROL RELEASE Needle Suture



Coated VICRYL® Plus Antibacterial (polyglactin 910) Suture



Taperpoint 						
Needle	Suture USP	Color	Length	EA/BX	Special	Product Code
 <p>CT-1 36mm 1/2 Circle</p>	0	Undyed	8 X 18"/45cm	12	CR	VCP840D*
	0	Violet	8 X 18"/45cm	12	CR	VCP740D*
	0	Undyed	1 X 27"/70cm	36		VCP260H
	0	Undyed	8 X 27"/70cm	12	CR	VCPP41D*
	0	Violet	1 X 27"/70cm	36		VCP340H
	0	Violet	8 X 27"/70cm	12	CR	VCPP31D*
	0	Undyed	1 X 36"/90cm	36		VCP946H
	0	Violet	1 X 36"/90cm	36		VCP346H
	1	Undyed	8 X 18"/45cm	12	CR	VCP841D*
	1	Violet	8 X 18"/45cm	12	CR	VCP741D*
	1	Undyed	1 X 27"/70cm	36		VCP261H
	1	Undyed	8 X 27"/70cm	12	CR	VCPP40D*
	1	Violet	1 X 27"/70cm	36		VCP341H
	1	Undyed	1 X 36"/90cm	36		VCP947H
1	Violet	1 X 36"/90cm	36		VCP347H	
 <p>MH 36mm 1/2 Circle</p>	3-0	Violet	1 X 27"/70cm	36		VCP322H
	2-0	Violet	1 X 27"/70cm	36		VCP323H
 <p>MO-4 36mm 1/2 Circle</p>	2-0	Violet	8 X 18"/45cm	12	CR	VCP700D*
	0	Violet	8 X 18"/45cm	12	CR	VCP701D*
	0	Violet	1 X 27"/70cm	36		VCP436H
	0	Violet	8 X 27"/70cm	12	CR	VCPP71D*
	1	Violet	8 X 18"/45cm	12	CR	VCP702D*
	1	Violet	1 X 27"/70cm	36		VCP437H

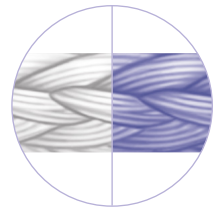





Coated VICRYL® Plus Antibacterial (polyglactin 910) Suture

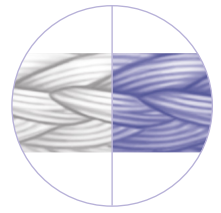

Taperpoint 						
Needle	Suture USP	Color	Length	EA/BX	Special	Product Code
 <p>CT 40mm 1/2 Circle</p>	3-0	Undyed	1 X 36"/90cm	36		VCP956H
	3-0	Violet	1 X 36"/90cm	36		VCP356H
	2-0	Violet	8 X 18"/45cm	12	CR	VCP715D*
	2-0	Undyed	1 X 27"/70cm	36		VCP275H
	2-0	Violet	1 X 27"/70cm	36		VCP351H
	2-0	Undyed	1 X 36"/90cm	36		VCP957H
	2-0	Violet	1 X 36"/90cm	36		VCP357H
	0	Violet	8 X 18"/45cm	12	CR	VCP752D*
	0	Undyed	1 X 27"/70cm	36		VCP280H
	0	Violet	1 X 27"/70cm	36		VCP352H
	0	Undyed	1 X 36"/90cm	36		VCP958H
	0	Violet	1 X 36"/90cm	36		VCP358H
	1	Violet	8 X 18"/45cm	12	CR	VCP753D*
	1	Undyed	1 X 27"/70cm	36		VCP281H
	1	Violet	1 X 27"/70cm	36		VCP353H
	1	Undyed	1 X 36"/90cm	36		VCP959H
1	Violet	1 X 36"/90cm	36		VCP359H	
 <p>CTX 40mm 1/2 Circle</p>	3-0	Undyed	1 X 36"/90cm	36		VCP980H
	2-0	Undyed	8 X 18"/45cm	12	CR	VCP723D*
	2-0	Violet	1 X 27"/70cm	36		VCP363H
	2-0	Undyed	1 X 36"/90cm	36		VCP979H
	2-0	Violet	1 X 36"/90cm	36		VCP369H

Coated VICRYL® Plus Antibacterial (polyglactin 910) Suture





Taperpoint 						
Needle	Suture USP	Color	Length	EA/BX	Special	Product Code
 <p>CTX 40mm 1/2 Circle</p>	0	Undyed	8 X 18"/45cm	12	CR	VCP724D*
	0	Violet	8 X 18"/45cm	12	CR	VCP764D*
	0	Violet	1 X 27"/70cm	36		VCP364H
	0	Undyed	1 X 36"/90cm	36		VCP978H
	0	Violet	1 X 36"/90cm	36		VCP370H
	1	Violet	8 X 18"/45cm	12	CR	VCP765D*
	1	Violet	1 X 27"/70cm	36		VCP365H
	1	Undyed	1 X 36"/90cm	36		VCP977H
	1	Violet	1 X 36"/90cm	36		VCP371H
 <p>TP-1 65mm 1/2 Circle</p>	2	Undyed	2 X 27"/70cm	12		VCP849G
	2	Violet	4 X 27"/70cm	12		VCP649G
	2	Undyed	1 X 54"/135cm	24		VCP880T
 <p>XLH 70mm 1/2 Circle</p>	2-0	Violet	1 X 27"/70cm	12		VCP581G
	1	Violet	1 X 27"/70cm	12		VCP583G
 <p>UR-6 26mm 5/8 Circle</p>	2-0	Violet	1 X 27"/70cm	36		VCP602H
	0	Violet	1 X 27"/70cm	36		VCP603H
 <p>UR-5 36mm 5/8 Circle</p>	2-0	Violet	1 X 27"/70cm	36		VCP375H
	0	Violet	1 X 27"/70cm	36		VCP376H

*Safety organizer tray **CR** CONTROL RELEASE Needle Suture

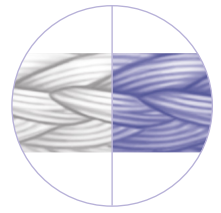

General Information	Needle Index	True-to-Scale Needle Diagram	Suturing	Knotless Tissue Control Devices	Sutures: Plus Antibacterial
Sutures: Absorbable	Sutures: Nonabsorbable				

Coated VICRYL® Plus Antibacterial (polyglactin 910) Suture







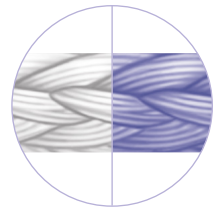

Tapercut Cardio 						
Needle	Suture USP	Color	Length	EA/BX	Special	Product Code
 V-34 36mm 1/2 Circle	3-0	Undyed	1 X 36"/90cm	36		VCP916H
	2-0	Undyed	1 X 36"/90cm	36		VCP917H

Tapercut 						
Needle	Suture USP	Color	Length	EA/BX	Special	Product Code
 V-34 36mm 1/2 Circle	3-0	Violet	1 X 36"/90cm	36		VCP516H
	2-0	Violet	1 X 36"/90cm	36		VCP517H
	0	Violet	1 X 36"/90cm	36		VCP518H
	1	Violet	1 X 36"/90cm	36		VCP519H

Reverse Cutting 						
Needle	Suture USP	Color	Length	EA/BX	Special	Product Code
 FS-2 19mm 3/8 Circle	5-0	Violet	1 X 18"/45cm	36		VCP391H
	5-0	Undyed	1 X 27"/70cm	36		VCP421H
	4-0	Violet	1 X 18"/45cm	36		VCP392H
	4-0	Undyed	1 X 27"/70cm	36		VCP422H
	3-0	Violet	1 X 18"/45cm	36		VCP393H
	3-0	Undyed	1 X 27"/70cm	36		VCP423H

Coated VICRYL® Plus Antibacterial (polyglactin 910) Suture





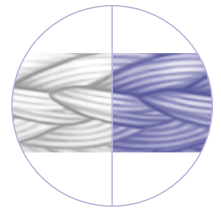

Reverse Cutting ▾						
Needle	Suture USP	Color	Length	EA/BX	Special	Product Code
 FS-1 24mm 3/8 Circle	4-0	Undyed	1 X 27"/70cm	36		VCP441H
	4-0	Violet	1 X 27"/70cm	36		VCP451H
	3-0	Undyed	1 X 27"/70cm	36		VCP422H
	3-0	Violet	1 X 27"/70cm	36		VCP452H
	2-0	Undyed	1 X 27"/70cm	36		VCP443H
 FS 26mm 3/8 Circle	3-0	Violet	8 X 18"/45cm	12	CR	VCP787D*
	3-0	Violet	8 X 18"/45cm	12	CR	VCP787Z
 FSL 30mm 3/8 Circle	3-0	Undyed	1 X 27"/70cm	36		VCP588H
	2-0	Undyed	1 X 27"/70cm	36		VCP589H
 PSL 30mm 3/8 Circle	3-0	Undyed	1 X 27"/70cm	36		VCP502H
	2-0	Undyed	1 X 27"/70cm	36		VCP596H
 OS-4 22mm 1/2 Circle	2-0	Undyed	3 X 18"/45cm	24	CR	VCP748T
	2-0	Violet	3 X 18"/45cm	24	CR	VCP706T
	0	Undyed	3 X 18"/45cm	24	CR	VCP749T
	0	Undyed	1 X 27"/70cm	36		VCP694H
	1	Violet	3 X 18"/45cm	24	CR	VCP708T
	1	Undyed	1 X 27"/70cm	36		VCP695H
 X-1 22mm 1/2 Circle	3-0	Violet	8 X 18"/45cm	12	CR	VCP790D*
	3-0	Undyed	1 X 27"/70cm	36		VCP458H
	3-0	Violet	1 X 27"/70cm	36		VCP460H
	2-0	Undyed	1 X 27"/70cm	36		VCP459H

General Information	Needle Index	True-to-Scale Needle Diagram	Suturing	Knotless Tissue Control Devices	Sutures: Plus Antibacterial
Sutures: Absorbable	Sutures: Nonabsorbable				

Coated VICRYL® Plus Antibacterial (polyglactin 910) Suture





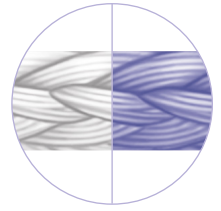

Reverse Cutting ▾						
Needle	Suture USP	Color	Length	EA/BX	Special	Product Code
 <p>CP-2 26mm 1/2 Circle</p>	3-0	Undyed	8 X 18"/45cm	12	CR	VCP761D*
	3-0	Undyed	1 X 27"/70cm	36		VCP868H
	2-0	Undyed	8 X 18"/45cm	12	CR	VCP762D*
	2-0	Undyed	1 X 27"/70cm	36		VCP869H
	0	Undyed	1 X 27"/70cm	36		VCP870H
	1	Undyed	1 X 27"/70cm	36		VCP871H
 <p>CP-1 36mm 1/2 Circle</p>	3-0	Undyed	1 X 27"/70cm	36		VCP265H
	2-0	Undyed	1 X 27"/70cm	36		VCP266H
	2-0	Violet	1 X 27"/70cm	36		VCP466H
	2-0	Violet	1 X 36"/90cm	36		VCP472H
	0	Undyed	1 X 27"/70cm	36		VCP267H
	0	Violet	1 X 27"/70cm	36		VCP467H
	1	Undyed	1 X 27"/70cm	36		VCP268H
	1	Violet	1 X 27"/70cm	36		VCP468H
 <p>OS-6 36mm 1/2 Circle</p>	2-0	Undyed	3 X 18"/45cm	24	CR	VCP750T
	2-0	Violet	3 X 18"/45cm	24	CR	VCP710T
	2-0	Undyed	1 X 27"/70cm	36		VCP533H
	0	Undyed	3 X 18"/45cm	24	CR	VCP754T
	0	Violet	3 X 18"/45cm	24	CR	VCP711T
	0	Undyed	1 X 27"/70cm	36		VCP534H
	1	Undyed	1 X 27"/70cm	36		VCP535H
 <p>CP 40mm 1/2 Circle</p>	2-0	Violet	1 X 27"/70cm	36		VCP478H
	0	Undyed	1 X 27"/70cm	36		VCP197H
	1	Undyed	1 X 27"/70cm	36		VCP196H
	1	Violet	1 X 27"/70cm	36		VCP480H
	1	Violet	1 X 36"/90cm	36		VCP486H
	2	Undyed	1 X 27"/70cm	36		VCP195H

*Safety organizer tray **CR** CONTROL RELEASE Needle Suture

Coated VICRYL® Plus Antibacterial (polyglactin 910) Suture







Reverse Cutting ▾						
Needle	Suture USP	Color	Length	EA/BX	Special	Product Code
 OS-8 40mm 1/2 Circle	2-0	Violet	3 X 18"/45cm	24	CR	VCP716T
	0	Undyed	3 X 18"/45cm	24	CR	VCP756T
	0	Violet	3 X 18"/45cm	24	CR	VCP717T
	0	Undyed	1 X 27"/70cm	36		VCP698H
	1	Undyed	3 X 18"/45cm	24	CR	VCP757T
	1	Violet	3 X 18"/45cm	24	CR	VCP718T
	1	Undyed	1 X 27"/70cm	36		VCP699H
 CPX 48mm 1/2 Circle	0	Undyed	1 X 27"/70cm	36		VCP568H
	1	Undyed	1 X 27"/70cm	36		VCP569H
 KS 60mm Straight	4-0	Undyed	1 X 27"/70cm	36		VCP662H
	3-0	Undyed	1 X 27"/70cm	36		VCP663H



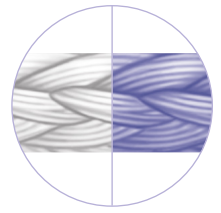



















Taperpoint ⊙ , Reverse Cutting ▾						
Needle	Suture USP	Color	Length	EA/BX	Special	Product Code
 CT, FSL 30mm 3/8 Circle	3-0	Undyed	1 X 54"/135cm	36		VCP940H

General Information	Needle Index	True-to-Scale Needle Diagram	Suturing	Knotless Tissue Control Devices	Sutures: Plus Antibacterial
Sutures: Absorbable	Sutures: Nonabsorbable				

Coated VICRYL® Plus Antibacterial (polyglactin 910) Suture









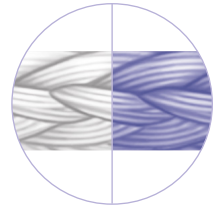











Taperpoint  , Reverse Cutting 						
Needle	Suture USP	Color	Length	EA/BX	Special	Product Code
 CT-1, CP-1 36mm 1/2 Circle	3-0	Undyed	1 X 54"/135cm	36		VCP931H

Prime Reverse Cutting 						
Needle	Suture USP	Color	Length	EA/BX	Special	Product Code
 P-1 11mm 3/8 Circle	5-0	Undyed	1 X 18"/45cm	12		VCP490G
 P-3 13mm 3/8 Circle	5-0	Undyed	1 X 18"/45cm	12		VCP493G
	5-0	Undyed	1 X 18"/45cm	36		VCP493H
	5-0	Violet	1 X 18"/45cm	12		VCP463G
	4-0	Undyed	1 X 18"/45cm	12		VCP494G
	4-0	Undyed	1 X 18"/45cm	36		VCP494H
	4-0	Violet	1 X 18"/45cm	12		VCP464G
 PS-3 16mm 3/8 Circle	5-0	Undyed	1 X 18"/45cm	12		VCP500G
	5-0	Undyed	1 X 18"/45cm	36		VCP500H
 PS-2 19mm 3/8 Circle	5-0	Undyed	1 X 18"/45cm	12		VCP495G
	5-0	Undyed	1 X 18"/45cm	36		VCP495H
	4-0	Undyed	1 X 18"/45cm	12		VCP496G
	4-0	Undyed	1 X 18"/45cm	36		VCP496H
	4-0	Undyed	1 X 27"/70cm	36		VCP426H
	3-0	Undyed	1 X 18"/45cm	12		VCP497G
	3-0	Undyed	1 X 18"/45cm	36		VCP497H
	3-0	Undyed	1 X 27"/70cm	36		VCP427H
	2-0	Undyed	1 X 27"/70cm	36		VCP428H

Coated VICRYL® Plus Antibacterial (polyglactin 910) Suture



Prime Reverse Cutting 						
Needle	Suture USP	Color	Length	EA/BX	Special	Product Code
 PS-1 24mm 3/8 Circle	4-0	Undyed	1 X 18"/45cm	12		VCP682G
	4-0	Undyed	1 X 18"/45cm	36		VCP682H
	4-0	Undyed	1 X 27"/70cm	36		VCP935H
	3-0	Undyed	1 X 18"/45cm	12		VCP683G
	3-0	Undyed	1 X 18"/45cm	36		VCP683H
	3-0	Undyed	1 X 27"/70cm	36		VCP936H
 P-2 8mm 1/2 Circle	5-0	Undyed	1 X 18"/45cm	12		VCP503G
	4-0	Undyed	1 X 18"/45cm	12		VCP504G
 PS-6 10mm 1/2 Circle	5-0	Undyed	1 X 18"/45cm	12		VCP511G
 PS-5 13mm 1/2 Circle	5-0	Undyed	1 X 18"/45cm	12		VCP593G
	4-0	Undyed	1 X 18"/45cm	12		VCP594G
 PS-4 16mm 1/2 Circle	5-0	Undyed	1 X 18"/45cm	12		VCP506G
	4-0	Undyed	1 X 18"/45cm	12		VCP507G
 PS-4C 16mm Compound Curve	4-0	Undyed	1 X 18"/45cm	12		VCP656G

Prime Conventional Cutting 						
Needle	Suture USP	Color	Length	EA/BX	Special	Product Code
 PC-1 13mm 3/8 Circle	5-0	Undyed	1 X 18"/45cm	12		VCP834G
	4-0	Undyed	1 X 18"/45cm	12		VCP835G

Coated VICRYL® Plus Antibacterial (polyglactin 910) Suture

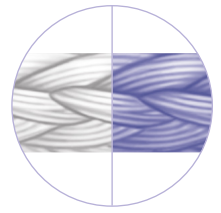

Prime Conventional Cutting						
Needle	Suture USP	Color	Length	EA/BX	Special	Product Code
PC-3 16mm 3/8 Circle	5-0	Undyed	1 X 18"/45cm	12	MultiPass NEEDLES	VCP844G
	4-0	Undyed	1 X 18"/45cm	12	MultiPass NEEDLES	VCP845G
PC-5 19mm 3/8 Circle	5-0	Undyed	1 X 18"/45cm	12	MultiPass NEEDLES	VCP822G
	4-0	Undyed	1 X 18"/45cm	12	MultiPass NEEDLES	VCP823G
	4-0	Undyed	1 X 18"/45cm	36	MultiPass NEEDLES	VCP823H
	3-0	Undyed	1 X 18"/45cm	12	MultiPass NEEDLES	VCP824G

Ligapak Reel						
Needle	Suture USP	Color	Length	EA/BX	Special	Product Code
	4-0	Undyed	1 X 54"/135cm	12		VCP284G
	3-0	Undyed	1 X 54"/135cm	12		VCP285G
	3-0	Violet	1 X 54"/135cm	12		VCP205G
	3-0	Undyed	1 X 144"/366cm	12		VCP885G
	2-0	Undyed	1 X 54"/135cm	12		VCP286G
	0	Undyed	1 X 54"/135cm	12		VCP287G
	0	Violet	1 X 54"/135cm	12		VCP207G
	1	Violet	1 X 54"/135cm	12		VCP208G

No Needle						
Needle	Suture USP	Color	Length	EA/BX	Special	Product Code
	4-0	Undyed	12 X 18"/45cm	12		VCP109G
	4-0	Violet	12 X 18"/45cm	12		VCP103G
	3-0	Undyed	3 X 18"/45cm	36		VCP644H
	3-0	Violet	3 X 18"/45cm	24		VCP634T

General Information	Needle Index	True-to-Scale Needle Diagram	Suturing	Knotless Tissue Control Devices	Sutures: Plus Antibacterial
Sutures: Absorbable	Sutures: Nonabsorbable				

Coated VICRYL® Plus Antibacterial (polyglactin 910) Suture

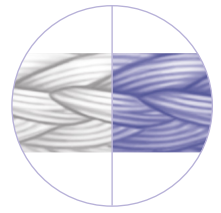

No Needle						
Needle	Suture USP	Color	Length	EA/BX	Special	Product Code
	3-0	Undyed	12 X 18"/45cm	12		VCP110G
	3-0	Violet	12 X 18"/45cm	12		VCP104G
	2-0	Undyed	3 X 18"/45cm	24		VCP645T
	2-0	Violet	3 X 18"/45cm	24		VCP635T
	2-0	Undyed	12 X 18"/45cm	12		VCP111G
	2-0	Violet	12 X 18"/45cm	12		VCP105G
	2-0	Undyed	1 X 54"/135cm	36		VCP607H
	2-0	Violet	1 X 54"/135cm	36		VCP615H
	0	Undyed	3 X 18"/45cm	24		VCP646T
	0	Violet	3 X 18"/45cm	24		VCP636T
	0	Undyed	6 X 18"/45cm	12		VCP112G
	0	Violet	6 X 18"/45cm	12		VCP106G
	0	Undyed	1 X 54"/135cm	36		VCP608H
	0	Violet	1 X 54"/135cm	36		VCP616H
	1	Violet	6 X 18"/45cm	12		VCP107G
	1	Violet	1 X 54"/135cm	36		VCP617H
	2	Violet	1 X 54"/135cm	36		VCP618H

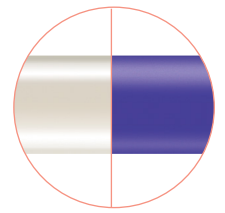

MONOCRYL[®] Plus Antibacterial (poliglecaprone 25) Suture

MONOCRYL Plus Sutures are ideal for subcuticular skin closure.



- High initial breaking strength to maintain wound approximation during the critical first few days of skin healing¹
- Shown in vitro to inhibit bacterial colonization of the suture
- Monofilament design and polymer properties minimize drag force and elicit only a slight tissue reaction during absorption¹





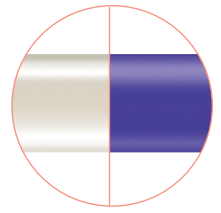

General Information	Needle Index	True-to-Scale Needle Diagram	Suturing	Knotless Tissue Control Devices	Sutures: Plus Antibacterial
Sutures: Absorbable	Sutures: Nonabsorbable				

MONOCRYL® Plus Antibacterial (poliglecaprone 25) Suture







Blunt Point ETHIGUARD 						
Needle	Suture USP	Color	Length	EA/BX	Special	Product Code
 SHB 26mm 1/2 Circle	3-0	Undyed	1 x 27"/70cm	36		MCPB416H
	3-0	Violet	1 x 27"/70cm	36		MCPB316H
 CTB-1 36mm 1/2 Circle	3-0	Undyed	1 x 36"/90cm	36		MCPB944H
	2-0	Undyed	1 x 36"/90cm	36		MCPB945H
	0	Undyed	1 x 36"/90cm	36		MCPB946H
	0	Violet	1 x 36"/90cm	36		MCPB346H

Taperpoint 						
Needle	Suture USP	Color	Length	EA/BX	Special	Product Code
 RB-1 17mm 1/2 Circle	5-0	Undyed	1 x 27"/70cm	36		MCP213H
	4-0	Undyed	1 x 27"/70cm	36		MCP214H
	4-0	Violet	1 x 27"/70cm	36		MCP304H
 CT-2 26mm 1/2 Circle	2-0	Violet	1 x 27"/70cm	36		MCP333H
 SH 26mm 1/2 Circle	4-0	Undyed	1 x 27"/70cm	36		MCP415H
	4-0	Violet	1 x 27"/70cm	36		MCP315H
	3-0	Undyed	1 x 27"/70cm	36		MCP416H
	3-0	Violet	1 x 27"/70cm	36		MCP316H
	2-0	Undyed	1 x 27"/70cm	36		MCP417H
	2-0	Violet	1 x 27"/70cm	36		MCP317H

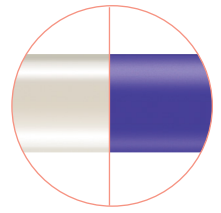
General Information	Needle Index	True-to-Scale Needle Diagram	Suturing	Knotless Tissue Control Devices	Sutures: Plus Antibacterial
Sutures: Absorbable	Sutures: Nonabsorbable				

MONOCRYL® Plus Antibacterial (poliglecaprone 25) Suture









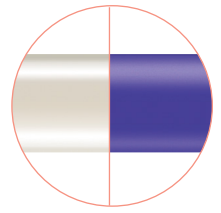













Taperpoint						
Needle	Suture USP	Color	Length	EA/BX	Special	Product Code
 CT-1 36mm 1/2 Circle	3-0	Undyed	1 X 36"/90cm	36		MCP944H
	3-0	Violet	1 X 36"/90cm	36		MCP344H
	2-0	Undyed	1 X 36"/90cm	36		MCP945H
	2-0	Violet	1 X 36"/90cm	36		MCP345H
	2-0	Violet	1 X 27"/70cm	36		MCP339H
	0	Undyed	1 X 36"/90cm	36		MCP946H
	0	Violet	1 X 36"/90cm	36		MCP346H
	0	Violet	1 X 27"/70cm	36		MCP340H
	1	Violet	1 X 36"/90cm	36		MCP347H
 CT 40mm 1/2 Circle	0	Violet	1 X 36"/90cm	36		MCP358H
 UR-6 26mm 5/8 Circle	3-0	Violet	1 X 27"/70cm	36		MCP604H
	2-0	Violet	1 X 27"/70cm	36		MCP605H
 UR-5 36mm 5/8 Circle	2-0	Violet	1 X 27"/70cm	36		MCP377H

General Information	Needle Index	True-to-Scale Needle Diagram	Suturing	Knotless Tissue Control Devices	Sutures: Plus Antibacterial
Sutures: Absorbable	Sutures: Nonabsorbable				

MONOCRYL® Plus Antibacterial (poliglecaprone 25) Suture











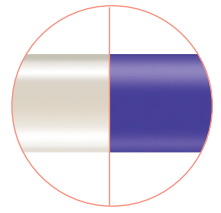

Reverse Cutting ▾						
Needle	Suture USP	Color	Length	EA/BX	Special	Product Code
 CP-1 36mm 1/2 Circle	2-0	Undyed	1 X 27"/70cm	36		MCP266H
 KS 60mm Straight	3-0	Undyed	1 X 27"/70cm	36		MCP523H

Prime Reverse Cutting ▾						
Needle	Suture USP	Color	Length	EA/BX	Special	Product Code
 P-1 11mm 3/8 Circle	6-0	Undyed	1 X 18"/45cm	12		MCP489G
	5-0	Undyed	1 X 18"/45cm	12		MCP490G
 P-3 13mm 3/8 Circle	6-0	Undyed	1 X 18"/45cm	12		MCP492G
	5-0	Undyed	1 X 18"/45cm	12		MCP493G
	5-0	Violet	1 X 18"/45cm	12		MCP463G
	4-0	Undyed	1 X 18"/45cm	12		MCP494G
 PS-2 19mm 3/8 Circle	5-0	Undyed	1 X 18"/45cm	12		MCP495G
	4-0	Undyed	1 X 27"/70cm	36		MCP426H
	4-0	Undyed	1 X 18"/45cm	12		MCP496G
	4-0	Violet	1 X 18"/45cm	12		MCP513G
	3-0	Undyed	1 X 27"/70cm	36		MCP427H
	3-0	Undyed	1 X 18"/45cm	12		MCP497G
 PS-1 24mm 3/8 Circle	4-0	Undyed	1 X 27"/70cm	36		MCP935H
	4-0	Undyed	1 X 18"/45cm	36		MCP682H
	3-0	Undyed	1 X 27"/70cm	36		MCP936H

General Information	Needle Index	True-to-Scale Needle Diagram	Suturing	Knotless Tissue Control Devices	Sutures: Plus Antibacterial
Sutures: Absorbable	Sutures: Nonabsorbable				

MONOCRYL® Plus Antibacterial (poliglecaprone 25) Suture



Prime Conventional Cutting 						
Needle	Suture USP	Color	Length	EA/BX	Special	Product Code
 PC-1 13mm 3/8 Circle	5-0	Undyed	1 X 18"/45cm	12		<u>MCP834G</u>
	4-0	Undyed	1 X 18"/45cm	12		<u>MCP835G</u>
 PC-3 16mm 3/8 Circle	5-0	Undyed	1 X 18"/45cm	12		<u>MCP844G</u>
	4-0	Undyed	1 X 18"/45cm	12		<u>MCP845G</u>
 PC-5 19mm 3/8 Circle	5-0	Undyed	1 X 18"/45cm	12		<u>MCP822G</u>
	4-0	Undyed	1 X 18"/45cm	12		<u>MCP823G</u>

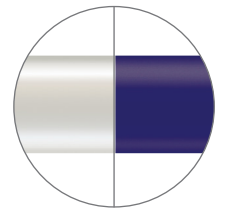

PDS[®] Plus Antibacterial (polydioxanone) Suture

PDS Plus Sutures are specifically designed for secure fascial closure in multiple patient types:



- Retains 60% of its original strength for 6 weeks, providing support to the fascia as it slowly heals
- Shown in vitro to inhibit bacterial colonization of the suture
- Monofilament design and polymer properties minimize drag force and elicit only a slight tissue reaction during absorption¹



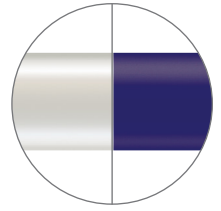

General Information	Needle Index	True-to-Scale Needle Diagram	Suturing	Knotless Tissue Control Devices	Sutures: Plus Antibacterial
Sutures: Absorbable	Sutures: Nonabsorbable				

PDS® Plus Antibacterial (polydioxanone) Suture









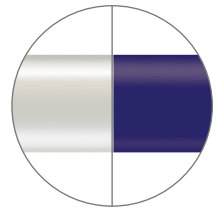

Blunt Point ●						
Needle	Suture USP	Color	Length	EA/BX	Special	Product Code
 <p>BP-2 48mm 1/2 Circle</p>	0	Violet	1x60"/150cm	12		PDPB990G
 <p>BP-1 65mm 1/2 Circle</p>	0	Violet	1x60"/150cm	12	Looped	PDPB991G
	1	Violet	1x96"/244cm	12	Looped	PDPB880G

Blunt Point ETHIGUARD ○						
Needle	Suture USP	Color	Length	EA/BX	Special	Product Code
 <p>SHB 26mm 1/2 Circle</p>	3-0	Violet	1x27"/70cm	36		PDPB316H
	2-0	Violet	1x27"/70cm	36		PDPB317H
 <p>CTB-2 26mm 1/2 Circle</p>	3-0	Violet	1x27"/70cm	36		PDPB332H
	2-0	Violet	1x27"/70cm	36		PDPB333H
	0	Violet	1x27"/70cm	36		PDPB334H
 <p>CTB-1 36mm 1/2 Circle</p>	2-0	Violet	1x27"/70cm	36		PDPB339H
	2-0	Violet	1x36"/90cm	36		PDPB345
	0	Violet	1x27"/70cm	36		PDPB340
	0	Violet	1x36"/90cm	36		PDPB346
	1	Violet	1x36"/90cm	36		PDPB347

PDS® Plus Antibacterial (polydioxanone) Suture









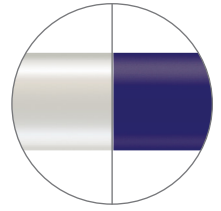

Blunt Point ETHIGUARD 						
Needle	Suture USP	Color	Length	EA/BX	Special	Product Code
 CTB 40mm 1/2 Circle	0	Violet	1x36"/90cm	24		PDPB358T
	1	Violet	1x36"/90cm	24		PDPB359T
 CTXB 48mm 1/2 Circle	0	Violet	1x36"/90cm	24		PDPB370
	1	Violet	1x36"/90cm	24		PDPB371
 TPB-1 65mm 1/2 Circle	1	Violet	1x54"/135cm	12		PDPB879G

Taperpoint 						
Needle	Suture USP	Color	Length	EA/BX	Special	Product Code
 BV-1 9.3mm 3/8 Circle	6-0	Violet	1 x 30"/75cm	36		PDP117H
 BV 11mm 3/8 Circle	6-0	Violet	1 x 30"/75cm	36		PDP123H
 C-1 13mm 3/8 Circle	6-0	Violet	1 x 30"/75cm	36		PDP127H
	5-0	Violet	1 x 30"/75cm	36		PDP126H

General Information	Needle Index	True-to-Scale Needle Diagram	Suturing	Knotless Tissue Control Devices	Sutures: Plus Antibacterial
Sutures: Absorbable	Sutures: Nonabsorbable				

PDS® Plus Antibacterial (polydioxanone) Suture







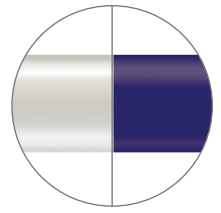

Taperpoint 						
Needle	Suture USP	Color	Length	EA/BX	Special	Product Code
 RB-2 13mm 1/2 Circle	6-0	Violet	1 x 30"/75cm	36		PDP149H
	5-0	Violet	1 x 30"/75cm	36		PDP148H
 TF 13mm 1/2 Circle	6-0	Violet	1 X 27"/70cm	36		PDP432H
	4-0	Violet	8 X 18"/45cm	12	CR	PDP802D*
 UCL 13mm 1/2 Circle	2-0	Violet	1 X 27"/70cm	36		PDP114H
 RB-1 17mm 1/2 Circle	5-0	Violet	8 X 24"/60cm	12		PDP800G
	5-0	Violet	1 X 27"/70cm	36		PDP303H
	4-0	Violet	8 X 24"/60cm	12	CR	PDP801D*
	4-0	Violet	1 X 27"/70cm	36		PDP304H
	4-0	Violet	8 X 27"/70cm	12	CR	PDP789D*
	3-0	Violet	1 X 27"/70cm	36		PDP305H
 RB-1 17mm 1/2 Circle	5-0	Violet	1 X 30"/75cm	36		PDP320H
 SH-1 22mm 1/2 Circle	4-0	Violet	1 X 27"/70cm	36		PDP310H
	3-0	Violet	8 X 24"/60cm	12	CR	PDP779D*
	3-0	Violet	1 X 27"/70cm	36		PDP311H

*Safety organizer tray **CR** CONTROL RELEASE Needle Suture

General Information	Needle Index	True-to-Scale Needle Diagram	Suturing	Knotless Tissue Control Devices	Sutures: Plus Antibacterial
Sutures: Absorbable	Sutures: Nonabsorbable				

PDS® Plus Antibacterial (polydioxanone) Suture







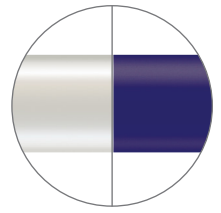

Taperpoint 						
Needle	Suture USP	Color	Length	EA/BX	Special	Product Code
 CT-2 26mm 1/2 Circle	3-0	Violet	1 x 27"/70cm	36		PDP332H
	2-0	Violet	1 x 27"/70cm	36		PDP333H
	0	Violet	1 x 27"/70cm	36		PDP334H
 SH 26mm 1/2 Circle	4-0	Violet	1 X 27"/70cm	36		PDP315H
	3-0	Violet	1 X 27"/70cm	36		PDP316H
	3-0	Violet	8 X 27"/70cm	12	CR	PDP780D*
	3-0	Undyed	1 X 27"/70cm	36		PDP416H
	2-0	Violet	1 X 27"/70cm	36		PDP317H
 CT-1 36mm 1/2 Circle	3-0	Violet	1 X 27"/70cm	36		PDP338H
	2-0	Violet	8 X 18"/45cm	12	CR	PDP739D*
	2-0	Violet	1 X 27"/70cm	36		PDP339H
	2-0	Undyed	1 X 27"/70cm	36		PDP259H
	0	Violet	1 X 27"/70cm	36		PDP340H
	0	Violet	1 X 36"/90cm	36		PDP346H
	1	Violet	1 X 27"/70cm	36		PDP341H
	1	Violet	1 X 36"/90cm	36		PDP347H
	 CT 40mm 1/2 Circle	2-0	Violet	1 X 36"/90cm	36	
0		Violet	1 X 27"/70cm	36		PDP352H
0		Violet	1 X 36"/90cm	24		PDP358T
1		Violet	1 X 27"/70cm	36		PDP353H
1		Violet	1 X 36"/90cm	24		PDP359T

*Safety organizer tray **CR** CONTROL RELEASE Needle Suture

General Information	Needle Index	True-to-Scale Needle Diagram	Suturing	Knotless Tissue Control Devices	Sutures: Plus Antibacterial
Sutures: Absorbable	Sutures: Nonabsorbable				

PDS® Plus Antibacterial (polydioxanone) Suture



Taperpoint 						
Needle	Suture USP	Color	Length	EA/BX	Special	Product Code
 <p>CTX 48mm 1/2 Circle</p>	O	Violet	8 X 18"/45cm	12	CR	PDP776D*
	O	Violet	1 X 36"/90cm	24		PDP370T
	O	Violet	1 X 60"/150cm	12	Looped	PDP990G
	1	Violet	1 X 36"/90cm	24		PDP371T
 <p>TP-1 65mm 1/2 Circle</p>	O	Violet	1 X 60"/150cm	12	Looped	PDP991G
	1	Violet	1 X 54"/135cm	12		PDP879G
	1	Violet	1 X 96"/244cm	12	Looped	PDP880G
 <p>XLH 70mm 1/2 Circle</p>	O	Violet	1 X 27"/70cm	12		PDP582G
	1	Violet	1 X 54"/135cm	12		PDP877G
	1	Violet	1 X 96"/244cm	12	Looped	PDP881G
 <p>ST-4 19mm Straight</p>	4-0	Violet	1 X 14"/35cm	12		PDP420G



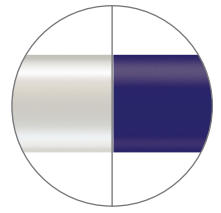

*Safety organizer tray  CONTROL RELEASE Needle Suture

General Information	Needle Index	True-to-Scale Needle Diagram	Suturing	Knotless Tissue Control Devices	Sutures: Plus Antibacterial
Sutures: Absorbable	Sutures: Nonabsorbable				

PDS® Plus Antibacterial (polydioxanone) Suture







Tapercut 						
Needle	Suture USP	Color	Length	EA/BX	Special	Product Code
 V-5 17mm 1/2 Circle	4-0	Violet	1 X 36"/90cm	36		PDP137H



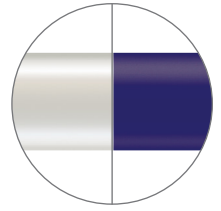



Reverse Cutting 						
Needle	Suture USP	Color	Length	EA/BX	Special	Product Code
 FS-2 19mm 3/8 Circle	5-0	Undyed	1 X 27"/70cm	36		PDP421H
	4-0	Undyed	1 X 27"/70cm	36		PDP422H
	3-0	Undyed	1 X 27"/70cm	36		PDP423H
 FS-1 24mm 3/8 Circle	4-0	Undyed	1 X 27"/70cm	36		PDP441H
	3-0	Undyed	1 X 27"/70cm	36		PDP442H
	2-0	Undyed	1 X 27"/70cm	36		PDP443H
 OS-4 22mm 1/2 Circle	1	Violet	1 X 27"/70cm	36		PDP695H
 CP-2 26mm 1/2 Circle	3-0	Violet	1 X 27"/70cm	36		PDP968H
	2-0	Violet	8 X 18"/45cm	12	CR	PDP762D*
	2-0	Violet	1 X 27"/70cm	36		PDP969H
	0	Violet	1 X 27"/70cm	36		PDP970H

*Safety organizer tray  CONTROL RELEASE Needle Suture

PDS® Plus Antibacterial (polydioxanone) Suture









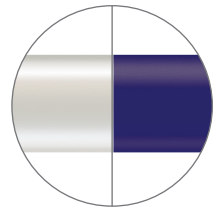













Reverse Cutting ▾						
Needle	Suture USP	Color	Length	EA/BX	Special	Product Code
 CP-1 36mm 1/2 Circle	2-0	Violet	1 X 27"/70cm	36		PDP466H
	0	Violet	1 X 27"/70cm	36		PDP467H
	1	Violet	1 X 27"/70cm	36		PDP468H
 OS-6 36mm 1/2 Circle	0	Violet	1 X 27"/70cm	24		PDP534T
	1	Violet	1 X 27"/70cm	36		PDP535H
 CPX 48mm 1/2 Circle	1	Violet	1 X 27"/70cm	24		PDP569T
 KS 60mm Straight	4-0	Undyed	1 X 27"/70cm	36		PDP662H
	3-0	Undyed	1 X 27"/70cm	36		PDP663H

Prime Reverse Cutting ▾						
Needle	Suture USP	Color	Length	EA/BX	Special	Product Code
 P-1 11mm 3/8 Circle	6-0	Violet	1 X 18"/45cm	12		PDP487G
	6-0	Undyed	1 X 18"/45cm	12		PDP489G
 P-3 13mm 3/8 Circle	5-0	Violet	1 X 18"/45cm	12		PDP463G
	5-0	Undyed	1 X 18"/45cm	12		PDP493G
	4-0	Undyed	1 X 18"/45cm	12		PDP494G

PDS® Plus Antibacterial (polydioxanone) Suture



Prime Reverse Cutting 						
Needle	Suture USP	Color	Length	EA/BX	Special	Product Code
 PS-2 19mm 3/8 Circle	5-0	Undyed	1 X 18"/45cm	12		PDP495G
	4-0	Undyed	1 X 18"/45cm	12		PDP496G
	4-0	Violet	1 X 18"/45cm	12		PDP513G
	3-0	Undyed	1 X 18"/45cm	12		PDP497G
 PS-1 24mm 3/8 Circle	4-0	Undyed	1 X 18"/45cm	12		PDP682G
	3-0	Undyed	1 X 18"/45cm	12		PDP683G
 P-2 8mm 1/2 Circle	5-0	Undyed	1 X 18"/45cm	12		PDP503G
	4-0	Undyed	1 X 18"/45cm	12		PDP504G
 PS-4 16mm 1/2 Circle	4-0	Undyed	1 X 18"/45cm	12		PDP507G

Prime Conventional Cutting 						
Needle	Suture USP	Color	Length	EA/BX	Special	Product Code
 PC-1 13mm 3/8 Circle	6-0	Undyed	1 X 18"/45cm	12		PDP833G
 PC-3 16mm 3/8 Circle	5-0	Undyed	1 X 18"/45cm	12		PDP844G
	4-0	Undyed	1 X 18"/45cm	12		PDP845G
 PC-5 19mm 3/8 Circle	4-0	Undyed	1 X 18"/45cm	12		PDP823G
	3-0	Undyed	1 X 18"/45cm	12		PDP824G

General Information	Needle Index	True-to-Scale Needle Diagram	Suturing	Knotless Tissue Control Devices	Sutures: Plus Antibacterial
Sutures: Absorbable	Sutures: Nonabsorbable				

Sutures: Absorbable



General Information	Needle Index	True-to-Scale Needle Diagram	Suturing	Knotless Tissue Control Devices	Sutures: Plus Antibacterial
Sutures: Absorbable	Sutures: Nonabsorbable				

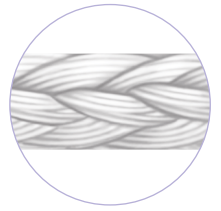





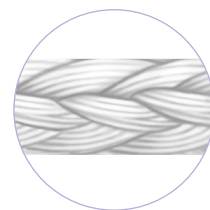

VICRYL RAPIDE™ (polyglactin 910) Suture

Coated VICRYL RAPIDE Suture is a synthetic absorbable sterile surgical suture composed of a copolymer made from 90% glycolide and 10% L-lactide.¹



VICRYL RAPIDE™ (polyglactin 910) Suture



Taperpoint 						
Needle	Suture USP	Color	Length	EA/BX	Special	Product Code
 RB-1 17mm 1/2 Circle	4-0	Undyed	1 X 27"/70cm	12		VR214
 SH 26mm 1/2 Circle	3-0	Undyed	1 X 27"/70cm	12		VR416
	2-0	Undyed	1 X 27"/70cm	12		VR417
 CT-1 36.4mm 1/2 Circle	3-0	Undyed	1 X 36"/90cm	12		VR944
	2-0	Undyed	1 X 36"/90cm	12		VR945
 CTX 48mm 1/2 Circle	0	Undyed	1 X 36"/90cm	12		VR1695

Tapercut 						
Needle	Suture USP	Color	Length	EA/BX	Special	Product Code
 V-34 36.4mm 1/2 Circle	3-0	Undyed	1 X 36"/90cm	12		VR916
	2-0	Undyed	1 X 36"/90cm	12		VR917
	0	Undyed	1 X 36"/90cm	36		VR2218



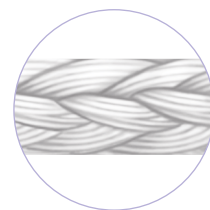

VICRYL RAPIDE™ (polyglactin 910) Suture



Taperpoint , Reverse Cutting 

Needle	Suture USP	Color	Length	EA/BX	Special	Product Code
 CT-1, CP-1 36.4mm 1/2 Circle	3-0	Undyed	1 X 54"/135cm	12		VR931
	2-0	Undyed	1 X 54"/135cm	12		VR932





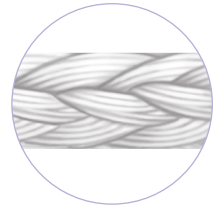

Prime Reverse Cutting 

Needle	Suture USP	Color	Length	EA/BX	Special	Product Code
 P-1 11mm 3/8 Circle	5-0	Undyed	1 X 18"/45cm	12		VR490
 P-3 13mm 3/8 Circle	5-0	Undyed	1 X 18"/45cm	12		VR493
	4-0	Undyed	1 X 18"/45cm	12		VR494
 PS-2 19mm 3/8 Circle	4-0	Undyed	1 X 27"/70cm	12		VR426
	4-0	Undyed	1 X 18"/45cm	12		VR496
	3-0	Undyed	1 X 18"/45cm	12		VR497
 PS-1 24mm 3/8 Circle	3-0	Undyed	1 X 27"/70cm	12		VR935

General Information	Needle Index	True-to-Scale Needle Diagram	Suturing	Knotless Tissue Control Devices	Sutures: Plus Antibacterial
Sutures: Absorbable	Sutures: Nonabsorbable				

VICRYL RAPIDE™ (polyglactin 910) Suture



Prime Conventional Cutting 						
Needle	Suture USP	Color	Length	EA/BX	Special	Product Code
 PC-1 13mm 3/8 Circle	5-0	Undyed	1 X 18"/45cm	12		<u>VR834</u>
	4-0	Undyed	1 X 18"/45cm	12		<u>VR835</u>
 PC-3 16mm 3/8 Circle	5-0	Undyed	1 X 18"/45cm	12		<u>VR844</u>
	4-0	Undyed	1 X 18"/45cm	12		<u>VR845</u>

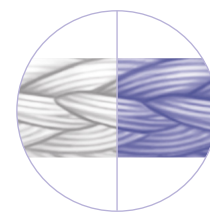

Coated VICRYL[®] (polyglactin 910) Suture

Coated VICRYL Suture is a synthetic absorbable sterile surgical suture composed of a copolymer made from 90% glycolide and 10% L-lactide.¹



Coated VICRYL Suture is indicated for use in general soft tissue approximation and/or ligation, including use in ophthalmic procedures, but not for use in cardiovascular and neurological tissues.¹

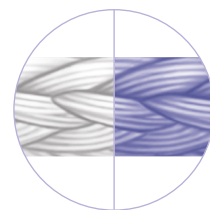

Coated VICRYL[®] (polyglactin 910) Suture









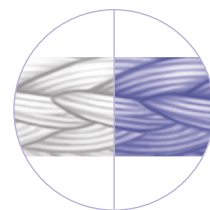



Blunt Point ETHIGUARD

Needle	Suture USP	Color	Length	EA/BX	Special	Product Code
 SHB 26mm 1/2 Circle	3-0	Undyed	8 X 18"/45cm	12	CR	<u>JB864</u>
 CTB-1 36mm 1/2 Circle	3-0	Undyed	1 x 36"/90cm	36		<u>JB944</u>
	2-0	Undyed	8 X 18"/45cm	12	CR	<u>JB839</u>
	2-0	Undyed	1 X 27"/70cm	36		<u>JB259</u>
	2-0	Undyed	1 x 36"/90cm	36		<u>JB945</u>
	0	Undyed	8 X 18"/45cm	12	CR	<u>JB840</u>
	0	Undyed	1 X 27"/70cm	36		<u>JB260</u>
	0	Violet	1 X 27"/70cm	36		<u>JB340</u>
	0	Undyed	1 x 36"/90cm	36		<u>JB946</u>
	1	Undyed	8 X 18"/45cm	12	CR	<u>JB841</u>
	1	Violet	1 X 27"/70cm	36		<u>JB341</u>
1	Undyed	1 x 36"/90cm	36		<u>JB947</u>	
 CTXB 48mm 1/2 Circle	0	Undyed	8 X 18"/45cm	12	CR	<u>JB724</u>
	0	Undyed	1 x 36"/90cm	36		<u>JB978</u>
	1	Undyed	8 X 18"/45cm	12	CR	<u>JB725</u>
	1	Undyed	1 x 36"/90cm	36		<u>JB977</u>

Coated VICRYL® (polyglactin 910) Suture



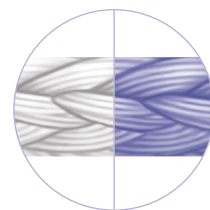

Taperpoint 						
Needle	Suture USP	Color	Length	EA/BX	Special	Product Code
 BV130-4 5mm 3/8 Circle	8-0	Violet	1 X 5"/13cm	12		<u>J405G</u>
 BV130-5 6.5mm 3/8 Circle	8-0	Violet	1 X 5"/13cm	12		<u>J401G</u>
 TF 13mm 1/2 Circle	5-0	Undyed	1 X 27"/70cm	36		<u>J433H</u>
	4-0	Violet	8 X 18"/45cm	12		<u>J743D*</u>
	4-0	Undyed	1 X 27"/70cm	36		<u>J434H</u>
 RB-1 17mm 1/2 Circle	6-0	Undyed	1 X 27"/70cm	36		<u>J212H</u>
	5-0	Undyed	1 X 27"/70cm	36		<u>J213H</u>
	5-0	Violet	1 X 27"/70cm	36		<u>J303H</u>
	4-0	Undyed	8 X 18"/45cm	12		<u>J714D*</u>
	4-0	Undyed	1 X 27"/70cm	36		<u>J214H</u>
	4-0	Violet	1 X 27"/70cm	36		<u>J304H</u>
	3-0	Violet	8 X 18"/45cm	12		<u>J713D*</u>
	3-0	Undyed	1 X 27"/70cm	36		<u>J215H</u>
	3-0	Violet	1 X 27"/70cm	36		<u>J305H</u>
	2-0	Violet	1 X 27"/70cm	36		<u>J306H</u>
 CT-3 22mm 1/2 Circle	3-0	Violet	1 X 27"/70cm	36		<u>J327H</u>
	2-0	Violet	1 X 27"/70cm	36		<u>J328H</u>
	0	Violet	1 X 27"/70cm	36		<u>J329H</u>

Coated VICRYL® (polyglactin 910) Suture





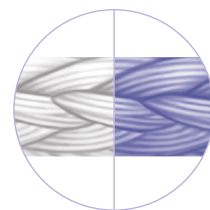

Taperpoint

Needle	Suture USP	Color	Length	EA/BX	Special	Product Code
 SH-1 22mm 1/2 Circle	4-0	Violet	8 X 18"/45cm	12	CR	<u>J771D*</u>
	4-0	Undyed	1 X 27"/70cm	36		<u>J218H</u>
	4-0	Violet	1 X 27"/70cm	36		<u>J310H</u>
	3-0	Violet	8 X 18"/45cm	12	CR	<u>J772D*</u>
	3-0	Undyed	1 X 27"/70cm	36		<u>J219H</u>
	3-0	Violet	1 X 27"/70cm	36		<u>J311H</u>
 CT-2 26mm 1/2 Circle	3-0	Undyed	1 X 27"/70cm	36		<u>J232H</u>
	3-0	Violet	1 X 27"/70cm	36		<u>J332H</u>
	2-0	Violet	8 X 18"/45cm	12	CR	<u>J726D*</u>
	2-0	Undyed	1 X 27"/70cm	36		<u>J269H</u>
	2-0	Violet	1 X 27"/70cm	36		<u>J333H</u>
	0	Violet	8 X 18"/45cm	12	CR	<u>J727D*</u>
	0	Undyed	1 X 27"/70cm	36		<u>J270H</u>
	0	Violet	1 X 27"/70cm	36		<u>J334H</u>
	1	Violet	1 X 27"/70cm	36		<u>J335H</u>
 MO-6 26mm 1/2 Circle	2-0	Violet	8 X 18"/45cm	12	CR	<u>J789D*</u>

Coated VICRYL[®] (polyglactin 910) Suture

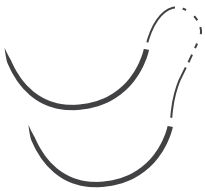

Taperpoint 						
Needle	Suture USP	Color	Length	EA/BX	Special	Product Code
 <p>SH 26mm 1/2 Circle</p>	4-0	Violet	8 X 18"/45cm	12	CR	<u>J773D*</u>
	4-0	Undyed	1 X 27"/70cm	36		<u>J415H</u>
	4-0	Violet	1 X 27"/70cm	36		<u>J315H</u>
	4-0	Violet	8 X 27"/70cm	12	CR	<u>J783G</u>
	3-0	Undyed	8 X 18"/45cm	12	CR	<u>J864D</u>
	3-0	Violet	8 X 18"/45cm	12	CR	<u>J774D*</u>
	3-0	Undyed	1 X 27"/70cm	36		<u>J416H</u>
	3-0	Violet	1 X 27"/70cm	36		<u>J316H</u>
	3-0	Violet	8 X 27"/70cm	12	CR	<u>J784G</u>
	2-0	Violet	8 X 18"/45cm	12	CR	<u>J775D*</u>
	2-0	Undyed	1 X 27"/70cm	36		<u>J417H</u>
	2-0	Violet	1 X 27"/70cm	36		<u>J317H</u>
	2-0	Violet	8 X 27"/70cm	12	CR	<u>J785G</u>
	0	Undyed	1 X 27"/70cm	36		<u>J418H</u>
 <p>SH 26mm 1/2 Circle</p>	3-0	Violet	1 x 36"/90cm	36		<u>J527H</u>
 <p>MO-5 31mm 1/2 Circle</p>	0	Violet	8 X 18"/45cm	12	CR	<u>J801D*</u>
	0	Violet	8 X 27"/70cm	12	CR	<u>JJ81G</u>
	1	Violet	8 X 27"/70cm	12	CR	<u>JJ80G</u>

Coated VICRYL® (polyglactin 910) Suture

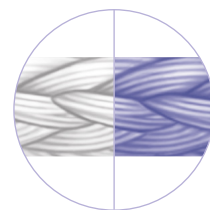



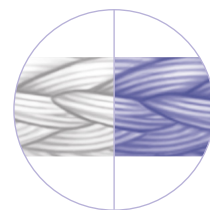

Taperpoint

Needle	Suture USP	Color	Length	EA/BX	Special	Product Code
 <p>CT-1 36mm 1/2 Circle</p>	4-0	Violet	1 X 27"/70cm	36		J337H
	3-0	Undyed	8 X 18"/45cm	12	CR	J838D*
	3-0	Violet	8 X 18"/45cm	12	CR	J738D*
	3-0	Undyed	1 X 27"/70cm	36		J258H
	3-0	Violet	1 X 27"/70cm	36		J338H
	3-0	Undyed	1 x 36"/90cm	36		J944H
	3-0	Violet	1 x 36"/90cm	36		J344H
	2-0	Undyed	8 X 18"/45cm	12	CR	J839D*
	2-0	Violet	8 X 18"/45cm	12	CR	J739D*
	2-0	Undyed	1 X 27"/70cm	36		J259H
	2-0	Violet	1 X 27"/70cm	36		J339H
	2-0	Undyed	8 X 27"/70cm	12	CR	JJ42G
	2-0	Undyed	1 x 36"/90cm	36		J945H
	2-0	Violet	1 x 36"/90cm	36		J345H
	0	Undyed	8 X 18"/45cm	12	CR	J840D*
	0	Violet	8 X 18"/45cm	12	CR	J740D*
	0	Undyed	1 X 27"/70cm	36		J260H
	0	Violet	1 X 27"/70cm	36		J340H
	0	Violet	3 X 27"/70cm	24		J430T
	0	Undyed	8 X 27"/70cm	12	CR	JJ41G
	0	Violet	8 X 27"/70cm	12	CR	JJ31G
	0	Undyed	1 x 36"/90cm	36		J946H
	0	Violet	1 x 36"/90cm	36		J346H
	1	Undyed	8 X 18"/45cm	12	CR	J841D*
	1	Violet	8 X 18"/45cm	12	CR	J741D*
	1	Undyed	1 X 27"/70cm	36		J261H
	1	Violet	1 X 27"/70cm	36		J341H
	1	Undyed	8 X 27"/70cm	12	CR	JJ40G
	1	Undyed	1 x 36"/90cm	36		J947H
	1	Violet	1 x 36"/90cm	36		J347H





Coated VICRYL[®] (polyglactin 910) Suture

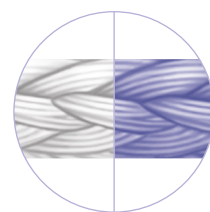

Taperpoint 						
Needle	Suture USP	Color	Length	EA/BX	Special	Product Code
 MH 36mm 1/2 Circle	3-0	Violet	1 X 27"/70cm	36		<u>J322H</u>
	2-0	Violet	1 X 27"/70cm	36		<u>J323H</u>
 MO-4 36mm 1/2 Circle	2-0	Violet	8 X 18"/45cm	12	CR	<u>J700D*</u>
	0	Violet	8 X 18"/45cm	12	CR	<u>J701D*</u>
	0	Violet	1 X 27"/70cm	36		<u>J436H</u>
	1	Violet	8 X 18"/45cm	12	CR	<u>J702D*</u>
	1	Violet	1 X 27"/70cm	36		<u>J437H</u>
 CT 40mm 1/2 Circle	3-0	Undyed	1 x 36"/90cm	36		<u>J956H</u>
	3-0	Violet	1 x 36"/90cm	36		<u>J356H</u>
	2-0	Violet	8 X 18"/45cm	12	CR	<u>J751D*</u>
	2-0	Undyed	1 X 27"/70cm	36		<u>J275H</u>
	2-0	Violet	1 X 27"/70cm	36		<u>J351H</u>
	2-0	Undyed	1 x 36"/90cm	36		<u>J957H</u>
	2-0	Violet	1 x 36"/90cm	36		<u>J357H</u>
	0	Violet	8 X 18"/45cm	12	CR	<u>J752D*</u>
	0	Undyed	1 X 27"/70cm	36		<u>J280H</u>
	0	Violet	1 X 27"/70cm	36		<u>J352H</u>
	0	Undyed	1 x 36"/90cm	36		<u>J958H</u>
	0	Violet	1 x 36"/90cm	36		<u>J358H</u>
	1	Violet	8 X 18"/45cm	12	CR	<u>J753D*</u>
	1	Undyed	1 X 27"/70cm	36		<u>J281H</u>
	1	Violet	1 X 27"/70cm	36		<u>J353H</u>
	1	Undyed	1 x 36"/90cm	36		<u>J959H</u>
1	Violet	1 x 36"/90cm	36		<u>J359H</u>	

Coated VICRYL[®] (polyglactin 910) Suture



Taperpoint 						
Needle	Suture USP	Color	Length	EA/BX	Special	Product Code
 <p>CTX 48mm 1/2 Circle</p>	3-0	Undyed	1 x 36"/90cm	36		J980H
	2-0	Undyed	8 X 18"/45cm	12	CR	J723D*
	2-0	Violet	1 X 27"/70cm	36		J363H
	2-0	Undyed	1 x 36"/90cm	36		J979H
	2-0	Violet	1 x 36"/90cm	36		J369H
	0	Undyed	8 X 18"/45cm	12	CR	J724D*
	0	Violet	8 X 18"/45cm	12	CR	J764D*
	0	Violet	1 X 27"/70cm	36		J364H
	0	Undyed	1 x 36"/90cm	36		J978H
	0	Violet	1 x 36"/90cm	36		J370H
	1	Violet	8 X 18"/45cm	12	CR	J765D*
	1	Violet	1 X 27"/70cm	36		J365H
	1	Undyed	1 x 36"/90cm	36		J977H
1	Violet	1 x 36"/90cm	36		J371H	
 <p>TP-1 65mm 1/2 Circle</p>	1	Violet	4 X 27"/70cm	12		J650G
	2	Undyed	2 X 27"/70cm	12		J849G
	2	Violet	4 X 27"/70cm	12		J649G
	2	Undyed	1 X 54"/135cm	24		J880T
 <p>XLH 70mm 1/2 Circle</p>	2-0	Violet	1 X 27"/70cm	12		J581G
	0	Violet	1 X 27"/70cm	12		J582G
	1	Violet	1 X 27"/70cm	12		J583G

Coated VICRYL[®] (polyglactin 910) Suture

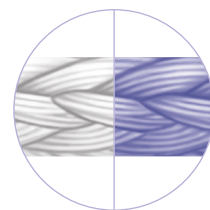

Taperpoint

Needle	Suture USP	Color	Length	EA/BX	Special	Product Code
 UR-6 26mm 5/8 Circle	2-0	Violet	1 X 27"/70cm	36		J602H
	0	Violet	1 X 27"/70cm	36		J603H
 UR-5 36mm 5/8 Circle	2-0	Violet	1 X 27"/70cm	36		J375H
	0	Violet	1 X 27"/70cm	36		J376H
 UR-4 40mm 5/8 Circle	0	Violet	1 X 27"/70cm	36		J381H
 TN 26mm Compound Curve	2-0	Violet	1 X 27"/70cm	12		JTN2G
	0	Violet	1 X 27"/70cm	12		JTN0G

Tapercut Cardio

Needle	Suture USP	Color	Length	EA/BX	Special	Product Code
 V130-5 5.8mm 1/4 Circle	8-0	Violet	1 X 9"/23cm	12		J409G
 V-34 36mm 1/2 Circle	3-0	Undyed	1 x 36"/90cm	36		J916H
	3-0	Violet	1 x 36"/90cm	36		J516H
	2-0	Undyed	1 x 36"/90cm	36		J917H
	2-0	Violet	1 x 36"/90cm	36		J517H
	0	Violet	1 x 36"/90cm	36		J518H
	1	Violet	1 x 36"/90cm	36		J519H

Coated VICRYL® (polyglactin 910) Suture

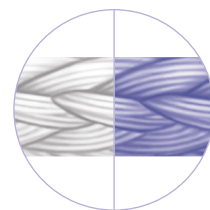

Tapercut Cardio

Needle	Suture USP	Color	Length	EA/BX	Special	Product Code
 V-38 31mm Fish Hook	0	Violet	1 X 18"/45cm	12		<u>J00JG</u>

Tapercut





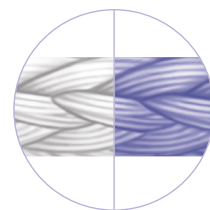

Needle	Suture USP	Color	Length	EA/BX	Special	Product Code
 V130-4 4.2mm 1/4 Circle	8-0	Violet	1 X 9"/23cm	12		<u>J408G</u>

Reverse Cutting

Needle	Suture USP	Color	Length	EA/BX	Special	Product Code
 C-3 13mm 3/8 Circle	5-0	Violet	1 X 18"/45cm	36		<u>J385H</u>
	4-0	Violet	1 X 18"/45cm	36		<u>J386H</u>
 FS-2 19mm 3/8 Circle	5-0	Violet	1 X 18"/45cm	36		<u>J391H</u>
	5-0	Undyed	1 X 27"/70cm	36		<u>J421H</u>
	4-0	Violet	1 X 18"/45cm	36		<u>J392H</u>
	4-0	Undyed	1 X 27"/70cm	36		<u>J422H</u>
	3-0	Violet	1 X 18"/45cm	36		<u>J393H</u>
	3-0	Undyed	1 X 27"/70cm	36		<u>J423H</u>





Coated VICRYL® (polyglactin 910) Suture

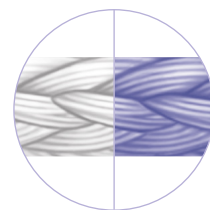

Reverse Cutting 						
Needle	Suture USP	Color	Length	EA/BX	Special	Product Code
 FS-1 24mm 3/8 Circle	4-0	Undyed	1 X 27"/70cm	36		J441H
	4-0	Violet	1 X 27"/70cm	36		J451H
	3-0	Undyed	1 X 27"/70cm	36		J442H
	2-0	Undyed	1 X 27"/70cm	36		J443H
 FS 26mm 3/8 Circle	3-0	Violet	8 X 18"/45cm	12	CR	J787D*
 FSL 30mm 3/8 Circle	3-0	Undyed	1 X 27"/70cm	36		J588H
	2-0	Undyed	1 X 27"/70cm	36		J589H
 PSL 30mm 3/8 Circle	3-0	Undyed	1 X 27"/70cm	36		J502H
	2-0	Undyed	1 X 27"/70cm	36		J596H
	0	Violet	1 X 27"/70cm	36		J610H
 J-1 17mm 1/2 Circle	4-0	Undyed	1 X 27"/70cm	36		J455H
 OS-4 22mm 1/2 Circle	2-0	Undyed	3 X 18"/45cm	24	CR	J748T
	2-0	Undyed	1 X 27"/70cm	36		J693H
	0	Undyed	3 X 18"/45cm	24	CR	J749T
	0	Violet	3 X 18"/45cm	24	CR	J707T
	0	Undyed	1 X 27"/70cm	36		J694H
	1	Violet	3 X 18"/45cm	24	CR	J708T
	1	Undyed	1 X 27"/70cm	36		J695H





Coated VICRYL® (polyglactin 910) Suture

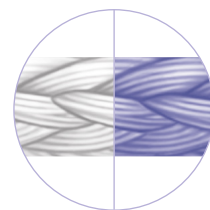

Reverse Cutting ▾						
Needle	Suture USP	Color	Length	EA/BX	Special	Product Code
 X-1 22mm 1/2 Circle	3-0	Violet	8 X 18"/45cm	12	CR	J790D*
	3-0	Undyed	1 X 27"/70cm	36		J458H
	3-0	Violet	1 X 27"/70cm	36		J460H
	2-0	Undyed	1 X 27"/70cm	36		J459H
	2-0	Violet	1 X 27"/70cm	36		J461H
 CP-2 26mm 1/2 Circle	3-0	Undyed	8 X 18"/45cm	12	CR	J761D*
	3-0	Undyed	1 X 27"/70cm	36		J868H
	2-0	Undyed	8 X 18"/45cm	12	CR	J762D*
	2-0	Undyed	1 X 27"/70cm	36		J869H
	0	Undyed	1 X 27"/70cm	36		J870H
	1	Undyed	1 X 27"/70cm	36		J871H
 CP-1 36mm 1/2 Circle	3-0	Violet	1 x 36"/90cm	36		J471H
	2-0	Undyed	1 X 27"/70cm	36		J266H
	2-0	Violet	1 X 27"/70cm	36		J466H
	2-0	Violet	1 x 36"/90cm	36		J472H
	0	Undyed	1 X 27"/70cm	36		J267H
	0	Violet	1 X 27"/70cm	36		J467H
	0	Violet	1 x 36"/90cm	36		J473H
	1	Undyed	1 X 27"/70cm	36		J268H
	1	Violet	1 X 27"/70cm	36		J468H
1	Violet	1 x 36"/90cm	36		J474H	
 OS-6 36mm 1/2 Circle	2-0	Undyed	3 X 18"/45cm	24	CR	J750T
	2-0	Violet	3 X 18"/45cm	24	CR	J710T
	2-0	Undyed	1 X 27"/70cm	36		J533H
	0	Undyed	3 X 18"/45cm	24	CR	J754T
	0	Violet	3 X 18"/45cm	24	CR	J711T
	0	Undyed	1 X 27"/70cm	36		J534H
	1	Undyed	1 X 27"/70cm	36		J535H

Coated VICRYL® (polyglactin 910) Suture



Reverse Cutting ▾						
Needle	Suture USP	Color	Length	EA/BX	Special	Product Code
 <p>CP 40mm 1/2 Circle</p>	0	Violet	1 X 27"/70cm	36		J479H
	0	Violet	1 x 36"/90cm	36		J485H
	1	Undyed	1 X 27"/70cm	36		J196H
	1	Violet	1 X 27"/70cm	36		J480H
	1	Violet	1 x 36"/90cm	36		J486H
	2	Undyed	1 X 27"/70cm	36		J195H
 <p>OS-8 40mm 1/2 Circle</p>	2-0	Violet	3 X 18"/45cm	24	CR	J716T
	0	Undyed	3 X 18"/45cm	24	CR	J756T
	0	Violet	3 X 18"/45cm	24	CR	J717T
	0	Undyed	1 X 27"/70cm	36		J698H
	1	Undyed	3 X 18"/45cm	24	CR	J757T
	1	Violet	3 X 18"/45cm	24	CR	J718T
	1	Undyed	1 X 27"/70cm	36		J699H
	2	Violet	3 X 18"/45cm	24	CR	J719T
 <p>CPX 48mm 1/2 Circle</p>	0	Undyed	1 X 27"/70cm	36		J568H
	1	Undyed	1 X 27"/70cm	36		J569H
 <p>KS 60mm Straight</p>	4-0	Undyed	1 X 27"/70cm	36		J662H
	3-0	Undyed	1 X 27"/70cm	36		J663H
	3-0	Violet	1 X 27"/70cm	36		J523H

Coated VICRYL® (polyglactin 910) Suture

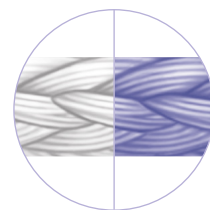

Taperpoint  , Reverse Cutting 

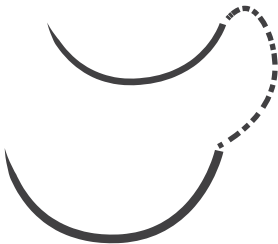
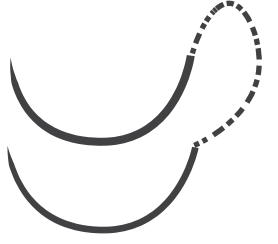







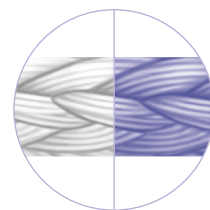



















Needle	Suture USP	Color	Length	EA/BX	Special	Product Code
 <p>CT, FSL 40mm 3/8, 1/2 Circle</p>	3-0	Undyed	1 X 54"/135cm	36		J940H
 <p>CT-1, CP-1 36mm 1/2 Circle</p>	3-0	Violet	1 X 54"/135cm	36		J531H
	2-0	Violet	1 X 54"/135cm	36		J532H

Prime Reverse Cutting 

Needle	Suture USP	Color	Length	EA/BX	Special	Product Code
 <p>G-6 8mm 1/4 Circle</p>	6-0	Violet	1 X 18"/45cm	12		J551G
 <p>P-1 11mm 3/8 Circle</p>	7-0	Undyed	1 X 18"/45cm	12		J488G
	6-0	Undyed	1 X 18"/45cm	12		J489G
	5-0	Undyed	1 X 18"/45cm	12		J490G
 <p>P-3 13mm 3/8 Circle</p>	6-0	Undyed	1 X 18"/45cm	12		J492G
	6-0	Undyed	1 X 18"/45cm	36		J492H
	5-0	Undyed	1 X 18"/45cm	12		J493G
	5-0	Undyed	1 X 18"/45cm	36		J493H
	5-0	Violet	1 X 18"/45cm	12		J463G
	4-0	Undyed	1 X 18"/45cm	12		J494G

Coated VICRYL[®] (polyglactin 910) Suture





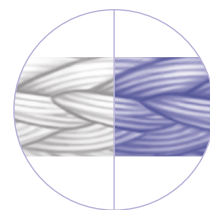

Prime Reverse Cutting 						
Needle	Suture USP	Color	Length	EA/BX	Special	Product Code
 P-3 13mm 3/8 Circle	4-0	Undyed	1 X 18"/45cm	36	 MultiPass [®] NEEDLES	J494H
	4-0	Violet	1 X 18"/45cm	12	 MultiPass [®] NEEDLES	J464G
 PS-3 16mm 3/8 Circle	6-0	Undyed	1 X 18"/45cm	12	 MultiPass [®] NEEDLES	J499G
	5-0	Undyed	1 X 18"/45cm	12	 MultiPass [®] NEEDLES	J500G
	5-0	Undyed	1 X 18"/45cm	36	 MultiPass [®] NEEDLES	J500H
 PS-2 19mm 3/8 Circle	5-0	Undyed	1 X 18"/45cm	12	 MultiPass [®] NEEDLES	J495G
	5-0	Undyed	1 X 18"/45cm	36	 MultiPass [®] NEEDLES	J495H
	4-0	Undyed	1 X 18"/45cm	12	 MultiPass [®] NEEDLES	J496G
	4-0	Undyed	1 X 18"/45cm	36	 MultiPass [®] NEEDLES	J496H
	4-0	Undyed	1 X 27"/70cm	36	 MultiPass [®] NEEDLES	J426H
	3-0	Undyed	1 X 18"/45cm	12	 MultiPass [®] NEEDLES	J497G
	3-0	Undyed	1 X 18"/45cm	36	 MultiPass [®] NEEDLES	J497H
	3-0	Undyed	1 X 27"/70cm	36	 MultiPass [®] NEEDLES	J427H
	2-0	Undyed	1 X 27"/70cm	36	 MultiPass [®] NEEDLES	J428H
 PS-1 24mm 3/8 Circle	4-0	Undyed	1 X 18"/45cm	12	 MultiPass [®] NEEDLES	J682G
	4-0	Undyed	1 X 18"/45cm	36	 MultiPass [®] NEEDLES	J682H
	4-0	Undyed	1 X 27"/70cm	36	 MultiPass [®] NEEDLES	J935H
	3-0	Undyed	1 X 18"/45cm	12	 MultiPass [®] NEEDLES	J683G
	3-0	Undyed	1 X 18"/45cm	36	 MultiPass [®] NEEDLES	J683H
	3-0	Undyed	1 X 27"/70cm	36	 MultiPass [®] NEEDLES	J936H
 P-2 8mm 1/2 Circle	5-0	Undyed	1 X 18"/45cm	12		J503G
	4-0	Undyed	1 X 18"/45cm	12		J504G
 PS-6 10mm 1/2 Circle	6-0	Undyed	1 X 18"/45cm	12		J510G
	5-0	Undyed	1 X 18"/45cm	12		J511G
 PS-5 13mm 1/2 Circle	5-0	Undyed	1 X 18"/45cm	12		J593G
	4-0	Undyed	1 X 18"/45cm	12		J594G

Coated VICRYL[®] (polyglactin 910) Suture







Prime Reverse Cutting

Needle	Suture USP	Color	Length	EA/BX	Special	Product Code
 PS-4 16mm 1/2 Circle	5-0	Undyed	1 X 18"/45cm	12		<u>J506G</u>
	4-0	Undyed	1 X 18"/45cm	12		<u>J507G</u>
 PS-4C 16mm Compound Curve	4-0	Undyed	1 X 18"/45cm	12		<u>J656G</u>
	3-0	Undyed	1 X 18"/45cm	12		<u>J657G</u>

Cutting Edge Conventional

Needle	Suture USP	Color	Length	EA/BX	Special	Product Code
 CCS-1 60mm 1/2 Circle	3	Undyed	1 X 27"/70cm	24		<u>J808T</u>

Prime Conventional Cutting

Needle	Suture USP	Color	Length	EA/BX	Special	Product Code
 PC-1 13mm 3/8 Circle	6-0	Undyed	1 X 18"/45cm	12		<u>J833G</u>
	5-0	Undyed	1 X 18"/45cm	12		<u>J834G</u>
	4-0	Undyed	1 X 18"/45cm	12		<u>J835G</u>
 PC-3 16mm 3/8 Circle	6-0	Undyed	1 X 18"/45cm	12		<u>J843G</u>
	5-0	Undyed	1 X 18"/45cm	12		<u>J844G</u>
	4-0	Undyed	1 X 18"/45cm	12		<u>J845G</u>

Coated VICRYL® (polyglactin 910) Suture

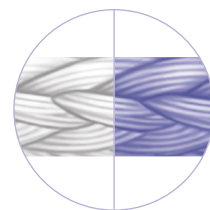

Prime Conventional Cutting

Needle	Suture USP	Color	Length	EA/BX	Special	Product Code
 PC-5 19mm 3/8 Circle	5-0	Undyed	1 X 18"/45cm	12	 MultiPass NEEDLES	J822G
	4-0	Undyed	1 X 18"/45cm	12	 MultiPass NEEDLES	J823G
	4-0	Undyed	1 X 18"/45cm	36	 MultiPass NEEDLES	J823H
	3-0	Undyed	1 X 18"/45cm	12	 MultiPass NEEDLES	J824G
 PC-12 16mm 1/2 Circle	5-0	Undyed	1 X 18"/45cm	12		J813G





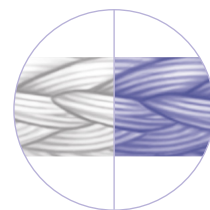

Spatula Conventional Cutting

Needle	Suture USP	Color	Length	EA/BX	Special	Product Code
 S-29 7.6mm 1/4 Circle	6-0	Violet	1 X 12"/30cm	12		J556G
	6-0	Violet	1 X 18"/45cm	12		J555G
 RD-1 8mm 1/4 Circle	6-0	Violet	1 X 12"/30cm	12		J446G
 S-28 7.6mm 1/2 Circle	6-0	Violet	1 X 18"/45cm	12		J562G

Coated VICRYL[®] (polyglactin 910) Suture



Spatula Reverse Cutting

Needle	Suture USP	Color	Length	EA/BX	Special	Product Code
 TG100-8 6.5mm 1/4 Circle	6-0	Violet	1 X 18"/45cm	12		J544G
 S-14 8mm 1/4 Circle	6-0	Violet	1 X 8"/20cm	12		J578G
	6-0	Violet	1 X 8"/20cm	12		J590G
	6-0	Violet	1 X 12"/30cm	12		J552G
	6-0	Undyed	1 X 18"/45cm	12		J670G
	6-0	Violet	1 X 18"/45cm	12		J570G
	5-0	Violet	1 X 8"/20cm	12		J579G
	5-0	Violet	1 X 8"/20cm	12		J591G
	5-0	Violet	1 X 12"/30cm	12		J553G
	5-0	Undyed	1 X 18"/45cm	12		J671G
	5-0	Violet	1 X 18"/45cm	12		J571G
 TG140-6 6.5mm 3/8 Circle	8-0	Violet	1 X 12"/30cm	12		J974G
 TG140-8 6.5mm 3/8 Circle	8-0	Violet	1 X 8"/20cm	12		J547G
	8-0	Violet	1 X 12"/30cm	12		J548G
	8-0	Violet	1 X 12"/30cm	12		J599G*
	7-0	Violet	1 X 12"/30cm	12		J566G
	7-0	Violet	1 X 18"/45cm	12		J546G
 TG160-6 5.5mm 1/2 Circle	8-0	Violet	1 X 12"/30cm	12		J975G
 TG160-8 5.5mm 1/2 Circle	8-0	Violet	1 X 8"/20cm	12		J574G
	7-0	Violet	1 X 12"/30cm	12		J575G
	7-0	Violet	1 X 18"/45cm	12		J576G

Coated VICRYL® (polyglactin 910) Suture

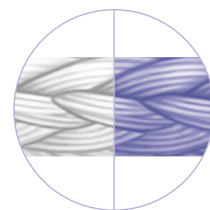

No Needle

Needle	Suture USP	Color	Length	EA/BX	Special	Product Code
	4-0	Undyed	3 X 18"/45cm	36		J643H
	4-0	Violet	3 X 18"/45cm	36		J633H
	4-0	Undyed	12 X 18"/45cm	24		J109T
	4-0	Violet	12 X 18"/45cm	24		J103T
	4-0	Violet	12 X 18"/45cm	12		J103G
	3-0	Undyed	3 X 18"/45cm	36		J644H
	3-0	Violet	3 X 18"/45cm	36		J634H
	3-0	Undyed	12 X 18"/45cm	24		J110T
	3-0	Undyed	12 X 18"/45cm	24		J910T
	3-0	Violet	12 X 18"/45cm	12		J104G
	3-0	Violet	12 X 18"/45cm	24		J104T
	3-0	Violet	12 X 18"/45cm	24		J904T
	3-0	Undyed	1 X 54"/135cm	36		J606H
	3-0	Violet	1 X 54"/135cm	36		J614H
	2-0	Undyed	3 X 18"/45cm	36		J645H
	2-0	Violet	3 X 18"/45cm	36		J635H
	2-0	Undyed	12 X 18"/45cm	24		J111T
	2-0	Undyed	12 X 18"/45cm	24		J911T
	2-0	Violet	12 X 18"/45cm	12		J105G
	2-0	Violet	12 X 18"/45cm	24		J105T
	2-0	Violet	12 X 18"/45cm	24		J905T
	2-0	Undyed	1 X 54"/135cm	36		J607H
	2-0	Violet	1 X 54"/135cm	36		J615H
	0	Undyed	3 X 18"/45cm	36		J646H
	0	Violet	3 X 18"/45cm	36		J636H
	0	Undyed	6 X 18"/45cm	24		J112T
	0	Violet	6 X 18"/45cm	12		J106G
	0	Violet	6 X 18"/45cm	24		J106T
	0	Undyed	12 X 18"/45cm	12		J912G
	0	Violet	12 X 18"/45cm	12		J906G
	0	Undyed	1 X 54"/135cm	36		J608H
	0	Violet	1 X 54"/135cm	36		J616H

General Information	Needle Index	True-to-Scale Needle Diagram	Suturing	Knotless Tissue Control Devices	Sutures: Plus Antibacterial
Sutures: Absorbable	Sutures: Nonabsorbable				

Coated VICRYL[®] (polyglactin 910) Suture

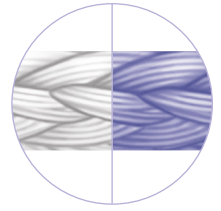

No Needle						
Needle	Suture USP	Color	Length	EA/BX	Special	Product Code
	1	Undyed	6 X 18"/45cm	24		J113T
	1	Undyed	12 X 18"/45cm	12		J913G
	1	Violet	12 X 18"/45cm	12		J907G
	1	Violet	1 X 54"/135cm	36		J617H
	2	Violet	1 X 54"/135cm	36		J618H

Ligapak Reel						
Needle	Suture USP	Color	Length	EA/BX	Special	Product Code
	5-0	Undyed	1 X 54"/135cm	12		J283G
	4-0	Undyed	1 X 54"/135cm	12		J284G
	4-0	Violet	1 X 54"/135cm	12		J204G
	3-0	Undyed	1 X 54"/135cm	12		J285G
	3-0	Violet	1 X 54"/135cm	12		J205G
	3-0	Undyed	1 X 144"/366cm	12		J885G
	2-0	Undyed	1 X 54"/135cm	12		J286G
	2-0	Violet	1 X 54"/135cm	12		J206G
	0	Undyed	1 X 54"/135cm	12		J287G
	0	Violet	1 X 54"/135cm	12		J207G
	1	Violet	1 X 54"/135cm	12		J208G

General Information	Needle Index	True-to-Scale Needle Diagram	Suturing	Knotless Tissue Control Devices	Sutures: Plus Antibacterial
Sutures: Absorbable	Sutures: Nonabsorbable				

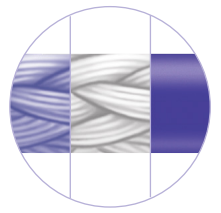

VICRYL[®] (polyglactin 910) Suture



VICRYL® (polyglactin 910) Suture

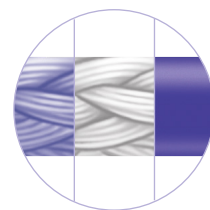

Taperpoint

Needle	Suture USP	Color/Construction	Length	EA/BX	Special	Product Code
 BV100-3 3.8mm 3/8 Circle	9-0	Violet/Monofilament	1 X 5"/13cm	12		V402G

Spatula Reverse Cutting

Needle	Suture USP	Color/Construction	Length	EA/BX	Special	Product Code
 TG140-8 6.5mm 3/8 Circle	9-0	Violet/Braided	1 X 12"/30cm	12		V549G

Ultima Reverse Cutting

Needle	Suture USP	Color/Construction	Length	EA/BX	Special	Product Code
 CS90-6 7mm 1/4 Circle	10-0	Violet/Monofilament	1 X 4"/10cm	12		V980G
 CS140-6 6.5mm 3/8 Circle	10-0	Violet/Monofilament	1 X 4"/10cm	12		V960G
	9-0	Violet/Braided	1 X 4"/10cm	12		V950G
 CS160-6 5.5mm 1/2 Circle	10-0	Violet/Monofilament	1 X 12"/30cm	12		V448G
 CS160-8 5.5mm 1/2 Circle	10-0	Violet/Monofilament	1 X 12"/30cm	12		V450G
	9-0	Violet/Monofilament	1 X 12"/30cm	12		V449G
 CS-B-6 5mm Compound Curve	10-0	Violet/Monofilament	1 X 4"/10cm	12		V966G

General Information	Needle Index	True-to-Scale Needle Diagram	Suturing	Knotless Tissue Control Devices	Sutures: Plus Antibacterial
Sutures: Absorbable	Sutures: Nonabsorbable				

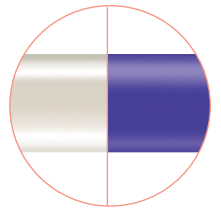

MONOCRYL[®] (poliglecaprone 25) Suture

MONOCRYL Suture is a monofilament synthetic absorbable surgical suture prepared from a copolymer of glycolide and epsilon-caprolactone.¹

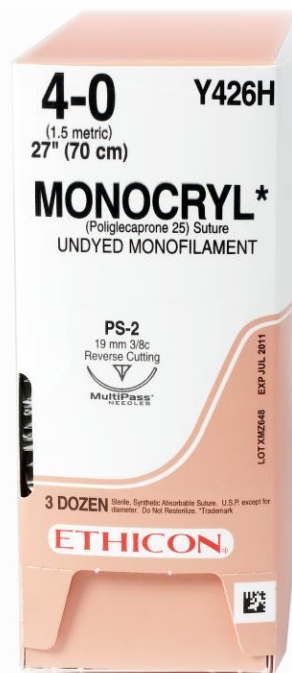

MONOCRYL Sutures are indicated for use in general soft tissue approximation and/or ligation, but not for use in cardiovascular or neurological tissues, microsurgery or ophthalmic surgery.¹

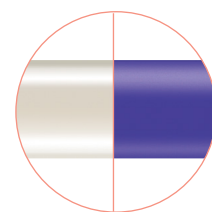

MONOCRYL® (poliglecaprone 25) Suture



Blunt Point ETHIGUARD

Needle	Suture USP	Color	Length	EA/BX	Special	Product Code
 SHB 26mm 1/2 Circle	3-0	Undyed	1 x 27"/70cm	36		YB416
 CTB-1 36mm 1/2 Circle	3-0	Undyed	1 x 36"/90cm	36		YB944
	2-0	Violet	1 x 27"/70cm	36		YB257
	0	Violet	1 x 27"/70cm	36		YB258
	0	Undyed	1 x 36"/90cm	36		YB946
 CTXB 48mm 1/2 Circle	1	Undyed	1 x 36"/90cm	36		YB947
	0	Undyed	1 x 36"/90cm	36		YB978



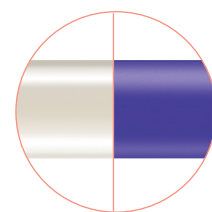

Taperpoint

Needle	Suture USP	Color	Length	EA/BX	Special	Product Code
 TF 13mm 1/2 Circle	6-0	Undyed	1 x 27"/70cm	36		Y432H
	5-0	Undyed	1 x 27"/70cm	36		Y433H
	4-0	Undyed	1 x 27"/70cm	36		Y434H

MONOCRYL® (poliglecaprone 25) Suture



Taperpoint

Needle	Suture USP	Color	Length	EA/BX	Special	Product Code
 RB-1 17mm 1/2 Circle	5-0	Undyed	1 X 27"/70cm	36		Y213H
	4-0	Undyed	1 X 27"/70cm	36		Y214H
	3-0	Undyed	1 X 27"/70cm	36		Y215H
	5-0	Violet	1 X 27"/70cm	36		Y303H
	4-0	Violet	1 X 27"/70cm	36		Y304H
	3-0	Violet	1 X 27"/70cm	36		Y305H
 SH-1 22mm 1/2 Circle	4-0	Undyed	1 X 27"/70cm	36		Y218H
	3-0	Undyed	1 X 27"/70cm	36		Y219H
	3-0	Undyed	8 X 18"/45cm	12	CR	Y872D*
 SH 26mm 1/2 Circle	4-0	Undyed	1 X 27"/70cm	36		Y415H
	4-0	Undyed	1 X 27"/70cm	36		Y315H
	3-0	Undyed	1 X 27"/70cm	36		Y416H
	3-0	Violet	1 X 27"/70cm	36		Y316H
	2-0	Undyed	1 X 27"/70cm	36		Y417H
	2-0	Violet	1 X 27"/70cm	36		Y317H
	2-0	Violet	1 X 27"/70cm	36		Y317H
	0	Violet	1 X 27"/70cm	36		Y318H
 SH 26mm 1/2 Circle	3-0	Violet	1 X 36"/90cm	36		Y527H

MONOCRYL® (poliglecaprone 25) Suture

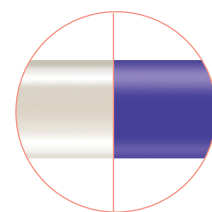





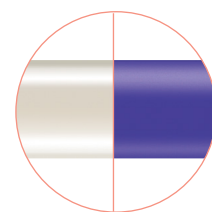

Taperpoint

Needle	Suture USP	Color	Length	EA/BX	Special	Product Code
 CT-2 26mm 1/2 Circle	2-0	Violet	1 X 27"/70cm	36		Y333H
	2-0	Violet	1 X 36"/90cm	36		Y762H
	0	Violet	1 X 27"/70cm	36		Y334H
	1	Violet	1 X 27"/70cm	36		Y335H
 MO-5 31mm 1/2 Circle	0	Violet	8 X 18"/45cm	12	CR	Y801D*
 MH 36mm 1/2 Circle	2-0	Undyed	1 X 27"/70cm	36		Y227H
 CT-1 36mm 1/2 Circle	3-0	Violet	8 X 18"/45cm	12	CR	Y738D*
	3-0	Violet	1 X 27"/70cm	36		Y338H
	3-0	Undyed	1 X 36"/90cm	36		Y944H
	3-0	Violet	1 X 36"/90cm	36		Y344H
	2-0	Violet	8 X 18"/45cm	12	CR	Y739D*
	2-0	Violet	1 X 27"/70cm	36		Y339H
	2-0	Undyed	1 X 36"/90cm	36		Y945H
	2-0	Violet	1 X 36"/90cm	36		Y345H
	0	Violet	8 X 18"/45cm	12	CR	Y740D*
	0	Violet	1 X 27"/70cm	36		Y340H
	0	Undyed	1 X 36"/90cm	36		Y946H
	0	Violet	1 X 36"/90cm	36		Y346H

MONOCRYL® (poliglecaprone 25) Suture



Taperpoint

Needle	Suture USP	Color	Length	EA/BX	Special	Product Code
 CT-1 36mm 1/2 Circle	0	Violet	4 X 27"/70cm	12	CR	YY31G
	1	Violet	1 X 27"/70cm	36		Y341H
	1	Violet	4 X 27"/70cm	12	CR	YY30G
	1	Undyed	1 X 36"/90cm	36		Y947H
	1	Violet	1 X 36"/90cm	36		Y347H
 MO-4 36mm 1/2 Circle	0	Violet	8 X 18"/45cm	12	CR	Y701D*
	0	Violet	4 X 27"/70cm	12	CR	YY71G
	1	Violet	4 X 27"/70cm	12	CR	YY70G
 CT 40mm 1/2 Circle	3-0	Violet	1 X 27"/70cm	36		Y350H
	2-0	Violet	1 X 27"/70cm	36		Y351H
	2-0	Violet	1 X 36"/90cm	36		Y357H
	0	Violet	1 X 27"/70cm	36		Y352H
	0	Violet	1 X 36"/90cm	36		Y358H
	1	Violet	1 X 27"/70cm	36		Y353H
	1	Violet	1 X 36"/90cm	36		Y359H
 CTX 48mm 1/2 Circle	2-0	Violet	1 X 36"/90cm	36		Y397H
	0	Violet	1 X 36"/90cm	36		Y398H
	1	Violet	1 X 36"/90cm	36		Y399H
 UR-6 26mm 5/8 Circle	3-0	Violet	1x27"/70cm	36		Y604H
	2-0	Violet	1x27"/70cm	36		Y605H
	0	Violet	1x27"/70cm	36		Y606H
 UR-5 36mm 5/8 Circle	2-0	Violet	1 X 27"/70cm	36		Y377H
	0	Violet	1 X 27"/70cm	36		Y378H

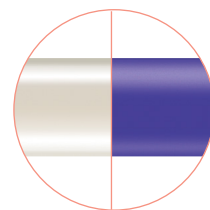

MONOCRYL® (poliglecaprone 25) Suture



Tapercut Cardio

Needle	Suture USP	Color	Length	EA/BX	Special	Product Code
 V-34 36mm 1/2 Circle	2-0	Undyed	1 X 27"/70cm	36		Y817H
	2-0	Undyed	1 X 36"/90cm	36		Y917H

Reverse Cutting

Needle	Suture USP	Color	Length	EA/BX	Special	Product Code
 CP-1 36mm 1/2 Circle	2-0	Undyed	1 X 27"/70cm	36		Y266H
	0	Undyed	1 X 27"/70cm	36		Y267H
 KS 60mm Straight	3-0	Undyed	1 X 27"/70cm	36		Y523H







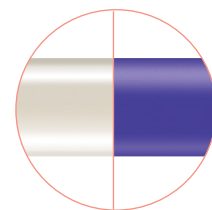













Taperpoint , Reverse Cutting

Needle	Suture USP	Color	Length	EA/BX	Special	Product Code
 CT-1, CP-1 36mm 1/2 Circle	3-0	Undyed	1 X 54"/135cm	36		Y931H
	2-0	Undyed	1 X 54"/135cm	36		Y932H

MONOCRYL® (poliglecaprone 25) Suture



Prime Reverse Cutting

Needle	Suture USP	Color	Length	EA/BX	Special	Product Code
 P-1 11mm 3/8 Circle	6-0	Undyed	1 X 18"/45cm	12	 MultiPass [®] NEEDLES	Y489G
	5-0	Undyed	1 X 18"/45cm	12	 MultiPass [®] NEEDLES	Y490G
 P-3 13mm 3/8 Circle	6-0	Undyed	1 X 18"/45cm	12	 MultiPass [®] NEEDLES	Y492G
	5-0	Undyed	1 X 18"/45cm	12	 MultiPass [®] NEEDLES	Y493G
	5-0	Violet	1 X 18"/45cm	12	 MultiPass [®] NEEDLES	Y463G
	4-0	Undyed	1 X 18"/45cm	12	 MultiPass [®] NEEDLES	Y494G
	4-0	Violet	1 X 18"/45cm	12	 MultiPass [®] NEEDLES	Y464G
 PS-2 19mm 3/8 Circle	5-0	Undyed	1 X 18"/45cm	12	 MultiPass [®] NEEDLES	Y495G
	4-0	Undyed	1 X 18"/45cm	12	 MultiPass [®] NEEDLES	Y496G
	4-0	Violet	1 X 18"/45cm	12	 MultiPass [®] NEEDLES	Y513G
	4-0	Undyed	1 X 27"/70cm	36	 MultiPass [®] NEEDLES	Y426H
	3-0	Undyed	1 X 18"/45cm	12	 MultiPass [®] NEEDLES	Y497G
	3-0	Undyed	1 X 27"/70cm	36	 MultiPass [®] NEEDLES	Y427H
 PS-1 24mm 3/8 Circle	4-0	Undyed	1 X 18"/45cm	36	 MultiPass [®] NEEDLES	Y682H
	4-0	Undyed	1 X 27"/70cm	36	 MultiPass [®] NEEDLES	Y935H
	3-0	Undyed	1 X 27"/70cm	36	 MultiPass [®] NEEDLES	Y936H
 PS-6 10mm 1/2 Circle	6-0	Undyed	1 X 18"/45cm	12		Y510G

Prime Conventional Cutting

Needle	Suture USP	Color	Length	EA/BX	Special	Product Code
 PC-1 13mm 3/8 Circle	6-0	Undyed	1 X 18"/45cm	12	 MultiPass [®] NEEDLES	Y833G
	5-0	Undyed	1 X 18"/45cm	12	 MultiPass [®] NEEDLES	Y834G
	4-0	Undyed	1 X 18"/45cm	12	 MultiPass [®] NEEDLES	Y835G

MONOCRYL® (poliglecaprone 25) Suture

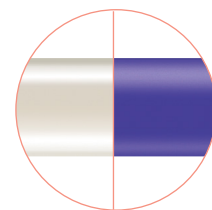

Prime Conventional Cutting

Needle	Suture USP	Color	Length	EA/BX	Special	Product Code
 PC-3 16mm 3/8 Circle	5-0	Undyed	1 X 18"/45cm	12		<u>Y844G</u>
	4-0	Undyed	1 X 18"/45cm	12		<u>Y845G</u>
 PC-5 19mm 3/8 Circle	5-0	Undyed	1 X 18"/45cm	12		<u>Y822G</u>
	4-0	Undyed	1 X 18"/45cm	12		<u>Y823G</u>
 PC-12 16mm 1/2 Circle	4-0	Undyed	1 X 18"/45cm	12		<u>Y814G</u>

No Needles

Needle	Suture USP	Color	Length	EA/BX	Special	Product Code
	3-0	Violet	6 X 18"/45cm	12		<u>Y908G</u>
	2-0	Violet	6 X 18"/45cm	12		<u>Y909G</u>
	0	Violet	6 X 18"/45cm	12		<u>Y910G</u>
	1	Violet	6 X 18"/45cm	12		<u>Y911G</u>

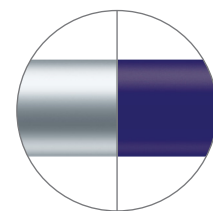

PDS[®] II (polydioxanone) Suture

PDS II Suture is prepared from the polyester, poly (p-dioxanone).¹

PDS II Sutures are indicated for use in soft tissue approximation, including use in pediatric cardiovascular tissue where growth is expected to occur and ophthalmic surgery. PDS II Suture is not indicated in adult cardiovascular tissue, microsurgery and neural tissue.¹

These sutures are particularly useful where the combination of an absorbable suture and extended wound support (up to six weeks) is desirable.¹



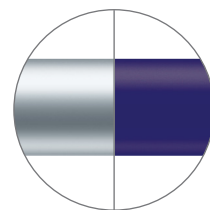

PDS® II (polydioxanone) Suture



Blunt Point ETHIGUARD







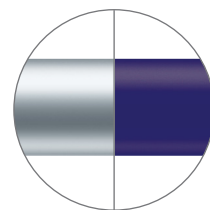

Needle	Suture USP	Color	Length	EA/BX	Special	Product Code
 CTB-1 36mm 1/2 Circle	2-0	Violet	1x36"/90cm	36		ZB345
	0	Violet	8 X 18"/45cm	12	CR	ZB740
	0	Violet	1x27"/70cm	36		ZB340
	0	Violet	1x36"/90cm	36		ZB346
	1	Violet	1x36"/90cm	36		ZB347
 CTXB 48mm 1/2 Circle	0	Violet	1x36"/90cm	24		ZB370
	1	Violet	1x36"/90cm	24		ZB371

Taperpoint

Needle	Suture USP	Color	Length	EA/BX	Special	Product Code
 BV-1 9.3mm 3/8 Circle	7-0	Violet	1x24"/60cm	36		Z155H
	7-0	Violet	1 x 30"/75cm	36		Z135H
	6-0	Violet	1 x 30"/75cm	36		Z117H
 BV 11mm 3/8 Circle	6-0	Violet	1 x 30"/75cm	36		Z123H
 C-1 13mm 3/8 Circle	6-0	Violet	1 x 30"/75cm	36		Z127H
	5-0	Violet	1 x 30"/75cm	36		Z126H





PDS® II (polydioxanone) Suture

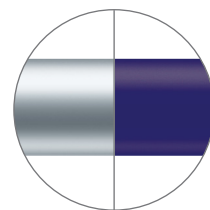

Taperpoint 						
Needle	Suture USP	Color	Length	EA/BX	Special	Product Code
 RB-2 13mm 1/2 Circle	6-0	Violet	1 x 30"/75cm	36		Z149H
	5-0	Violet	1 x 30"/75cm	36		Z148H
 TF 13mm 1/2 Circle	6-0	Violet	1 X 27"/70cm	36		Z432H
 UCL 13mm 1/2 Circle	2-0	Violet	1 X 27"/70cm	36		Z114H
 RB-1 17mm 1/2 Circle	5-0	Violet	1 X 27"/70cm	36		Z303H
	4-0	Violet	1 X 27"/70cm	36		Z304H
	3-0	Violet	1 X 27"/70cm	36		Z305H
 RB-1 17mm 1/2 Circle	5-0	Violet	1 X 30"/75cm	36		Z320H
 SH-1 22mm 1/2 Circle	4-0	Violet	1 X 27"/70cm	36		Z310H
	3-0	Violet	1 X 27"/70cm	36		Z311H
 CT-2 26mm 1/2 Circle	3-0	Violet	1 x 27"/70cm	36		Z332H
	2-0	Violet	1 x 27"/70cm	36		Z333H
	0	Violet	1 x 27"/70cm	36		Z334H





PDS® II (polydioxanone) Suture



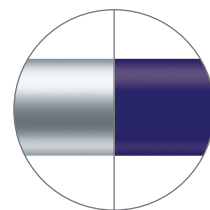

Taperpoint 						
Needle	Suture USP	Color	Length	EA/BX	Special	Product Code
 SH 26mm 1/2 Circle	4-0	Violet	8 X 18"/45cm	12	CR	Z773D*
	4-0	Violet	1 X 27"/70cm	36		Z315H
	3-0	Violet	8 X 18"/45cm	12	CR	Z774D*
	3-0	Undyed	1 X 27"/70cm	36		Z416H
	3-0	Violet	1 X 27"/70cm	36		Z316H
	2-0	Violet	8 X 18"/45cm	12	CR	Z775D*
	2-0	Violet	1 X 27"/70cm	36		Z317H
 CT-1 36mm 1/2 Circle	3-0	Violet	1 X 27"/70cm	36		Z338H
	2-0	Violet	8 X 18"/45cm	12	CR	Z739D*
	2-0	Undyed	1 X 27"/70cm	36		Z259H
	2-0	Violet	1 X 27"/70cm	36		Z339H
	0	Violet	8 X 18"/45cm	12	CR	Z740D*
	0	Violet	1 X 27"/70cm	36		Z340H
	0	Violet	1 X 36"/90cm	36		Z346H
	1	Violet	8 X 18"/45cm	12	CR	Z741D*
	1	Violet	1 X 27"/70cm	36		Z341H
	1	Violet	1 X 36"/90cm	36		Z347H
 CT 40mm 1/2 Circle	2-0	Violet	1 X 36"/90cm	36		Z357H
	0	Violet	1 X 27"/70cm	36		Z352H
	0	Violet	1 X 36"/90cm	24		Z358T
	1	Violet	1 X 27"/70cm	36		Z353H
	1	Violet	1 X 36"/90cm	24		Z359T

PDS® II (polydioxanone) Suture



Taperpoint 						
Needle	Suture USP	Color	Length	EA/BX	Special	Product Code
 <p>CTX 48mm 1/2 Circle</p>	0	Violet	8 X 18"/45cm	12	CR	Z776D*
	0	Violet	1 X 36"/90cm	24		Z370T
	0	Violet	1 X 60"/150cm	12	Looped	Z990G
	1	Violet	8 X 18"/45cm	12	CR	Z765D*
	1	Violet	1 X 36"/90cm	24		Z371T
 <p>TP-1 65mm 1/2 Circle</p>	0	Violet	1 X 60"/150cm	12	Looped	Z991G
	1	Violet	2 X 27"/70cm	12		Z690G
	1	Violet	1 X 54"/135cm	12		Z879G
	1	Violet	1 X 96"/244cm	12	Looped	Z880G
 <p>XLH 70mm 1/2 Circle</p>	1	Violet	1 X 27"/70cm	12		Z583G
	1	Violet	1 X 54"/135cm	12		Z877G
	1	Violet	1 X 96"/244cm	12	Looped	Z881G
 <p>ST-4 19mm Straight</p>	4-0	Violet	1 X 14"/35cm	12		Z420G

Tapercut Cardio 						
Needle	Suture USP	Color	Length	EA/BX	Special	Product Code
 <p>V-5 17mm 1/2 Circle</p>	4-0	Violet	1 X 36"/90cm	36		Z137H

PDS® II (polydioxanone) Suture

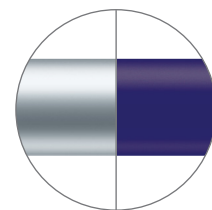



Tapercut Cardio

Needle	Suture USP	Color	Length	EA/BX	Special	Product Code
 <p>V-38 31mm Fish Hook</p>	0	Violet	1 X 18"/45cm	12		Z00JG

Trocar





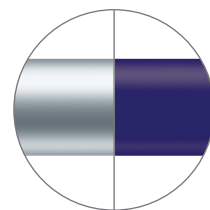

Needle	Suture USP	Color	Length	EA/BX	Special	Product Code
<p>STP-10 254mm Straight</p>	2-0	Violet	1 X 27"/70cm	12		Z997G

Reverse Cutting

Needle	Suture USP	Color	Length	EA/BX	Special	Product Code
 <p>FS-2 19mm 3/8 Circle</p>	5-0	Undyed	1 X 27"/70cm	36		Z421H
	4-0	Undyed	1 X 27"/70cm	36		Z422H
	3-0	Undyed	1 X 27"/70cm	36		Z423H
 <p>FS-1 24mm 3/8 Circle</p>	4-0	Undyed	1 X 27"/70cm	36		Z441H
	3-0	Undyed	1 X 27"/70cm	36		Z442H
	2-0	Undyed	1 X 27"/70cm	36		Z443H
 <p>OS-4 22mm 1/2 Circle</p>	1	Violet	1 X 27"/70cm	36		Z695H









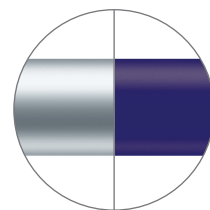











PDS® II (polydioxanone) Suture



Reverse Cutting ▾						
Needle	Suture USP	Color	Length	EA/BX	Special	Product Code
 <p>CP-2 26mm 1/2 Circle</p>	3-0	Violet	8 X 18"/45cm	12	CR	Z761D*
	3-0	Violet	1 X 27"/70cm	36		Z968H
	2-0	Violet	8 X 18"/45cm	12	CR	Z762D*
	2-0	Violet	1 X 27"/70cm	36		Z969H
	0	Violet	1 X 27"/70cm	36		Z970H
 <p>CP-1 36mm 1/2 Circle</p>	2-0	Violet	1 X 27"/70cm	36		Z466H
	0	Violet	1 X 27"/70cm	36		Z467H
	1	Violet	1 X 27"/70cm	36		Z468H
 <p>OS-6 36mm 1/2 Circle</p>	0	Violet	1 X 27"/70cm	24		Z534T
	1	Violet	1 X 27"/70cm	36		Z535H
 <p>CP 40mm 1/2 Circle</p>	2	Violet	1 X 27"/70cm	24		Z195T
 <p>CPX 48mm 1/2 Circle</p>	1	Violet	1 X 27"/70cm	24		Z569T
 <p>KS 60mm Straight</p>	4-0	Undyed	1 X 27"/70cm	36		Z662H
	3-0	Undyed	1 X 27"/70cm	36		Z663H

PDS® II (polydioxanone) Suture



Prime Reverse Cutting 						
Needle	Suture USP	Color	Length	EA/BX	Special	Product Code
 P-1 11mm 3/8 Circle	6-0	Undyed	1 X 18"/45cm	12		Z489G
	6-0	Violet	1 X 18"/45cm	12		Z487G
 P-3 13mm 3/8 Circle	5-0	Undyed	1 X 18"/45cm	12		Z493G
	5-0	Violet	1 X 18"/45cm	12		Z463G
	4-0	Undyed	1 X 18"/45cm	12		Z494G
 PS-2 19mm 3/8 Circle	5-0	Undyed	1 X 18"/45cm	12		Z495G
	4-0	Undyed	1 X 18"/45cm	12		Z496G
	4-0	Violet	1 X 18"/45cm	12		Z513G
	3-0	Undyed	1 X 18"/45cm	12		Z497G
 PS-1 24mm 3/8 Circle	4-0	Undyed	1 X 18"/45cm	12		Z682G
	3-0	Undyed	1 X 18"/45cm	12		Z683G
 P-2 8mm 1/2 Circle	5-0	Undyed	1 X 18"/45cm	12		Z503G
	4-0	Undyed	1 X 18"/45cm	12		Z504G
 PS-4 16mm 1/2 Circle	4-0	Undyed	1 X 18"/45cm	12		Z507G

PDS® II (polydioxanone) Suture

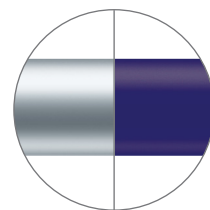

Conventional Cutting

Needle	Suture USP	Color	Length	EA/BX	Special	Product Code
 <p>CCS-1 60mm 1/2 Circle</p>	2	Violet	1 X 27"/70cm	24		<u>Z807I</u>

Prime Conventional Cutting

Needle	Suture USP	Color	Length	EA/BX	Special	Product Code
 <p>PC-1 13mm 3/8 Circle</p>	6-0	Undyed	1 X 18"/45cm	12		<u>Z833G</u>
 <p>PC-3 16mm 3/8 Circle</p>	5-0	Undyed	1 X 18"/45cm	12		<u>Z844G</u>
	4-0	Undyed	1 X 18"/45cm	12		<u>Z845G</u>
 <p>PC-5 19mm 3/8 Circle</p>	4-0	Undyed	1 X 18"/45cm	12		<u>Z823G</u>
	3-0	Undyed	1 X 18"/45cm	12		<u>Z824G</u>

General Information	Needle Index	True-to-Scale Needle Diagram	Suturing	Knotless Tissue Control Devices	Sutures: Plus Antibacterial
Sutures: Absorbable	Sutures: Nonabsorbable				

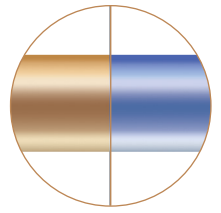

Surgical Gut Suture – Chromic

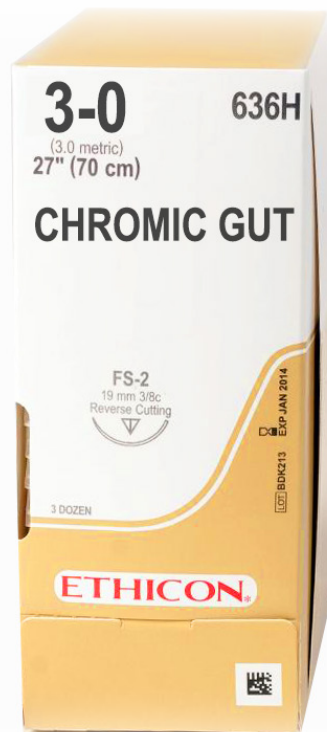

Surgical gut suture is an absorbable, sterile surgical suture composed of purified connective tissue (mostly collagen) derived from either the serosal layer of beef (bovine) or the submucosal fibrous layer of sheep (ovine) intestines. Surgical gut sutures are available in plain or chromic.¹

Surgical gut suture is indicated for use in general soft tissue approximation and/or ligation, including use in ophthalmic procedures, but not for use in cardiovascular and neurological tissues.¹

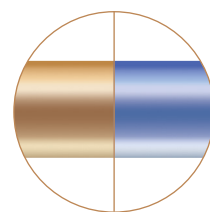

Surgical Gut Suture – Chromic

Blunt Point 







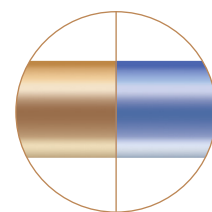

Needle	Suture USP	Color	Length	EA/BX	Special	Product Code
 BP-1 65mm 1/2 Circle	0	Brown	1 X 27"/70cm	24		<u>47I</u>
 BP 80mm 1/2 Circle	1	Brown	1 X 27"/70cm	12		<u>48G</u>

Taperpoint 

Needle	Suture USP	Color	Length	EA/BX	Special	Product Code
 C-1 13mm 3/8 Circle	5-0	Brown	1 X 27"/70cm	36		<u>K895H</u>
 BB 17mm 3/8 Circle	4-0	Brown	1 X 27"/70cm	12		<u>4887G</u>
 RB-1 17mm 1/2 Circle	5-0	Brown	1 X 27"/70cm	36		<u>U202H</u>
	4-0	Brown	1 X 27"/70cm	36		<u>U203H</u>
	3-0	Brown	1 X 27"/70cm	36		<u>U204H</u>



Surgical Gut Suture – Chromic



Taperpoint 						
Needle	Suture USP	Color	Length	EA/BX	Special	Product Code
 CT-3 22mm 1/2 Circle	3-0	Brown	1 X 27"/70cm	36		892H
	2-0	Brown	1 X 27"/70cm	36		893H
 SH-1 22mm 1/2 Circle	4-0	Brown	1 X 27"/70cm	36		G181H
	3-0	Brown	1 X 27"/70cm	36		G182H
 CT-2 26mm 1/2 Circle	3-0	Brown	1 x 27"/70cm	36		882H
	2-0	Brown	1 x 27"/70cm	36		883H
	0	Brown	1 x 27"/70cm	36		884H
	1	Brown	1 x 27"/70cm	36		885H
 SH 26mm 1/2 Circle	4-0	Brown	1 X 27"/70cm	36		G121H
	3-0	Brown	1 X 27"/70cm	36		G122H
	2-0	Brown	1 X 27"/70cm	36		G123H
	0	Brown	1 X 27"/70cm	36		G124H
 SH 26mm 1/2 Circle	3-0	Brown	1 X 36"/90cm	36		G172H
	2-0	Brown	1 X 36"/90cm	36		G173H
 MO-5 31mm 1/2 Circle	0	Brown	8 X 18"/45cm	12		CC04G
	1	Brown	8 X 18"/45cm	12		CC03G
	1	Brown	1 X 27"/70cm	36		4995H

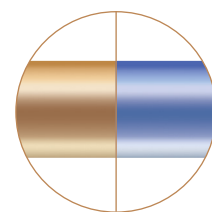

Surgical Gut Suture – Chromic

Taperpoint 

Needle	Suture USP	Color	Length	EA/BX	Special	Product Code
 <p>CT-1 36mm 1/2 Circle</p>	3-0	Brown	1 X 27"/70cm	36		810H
	3-0	Brown	1 X 36"/90cm	36		922H
	2-0	Brown	1 X 27"/70cm	36		811H
	2-0	Brown	3 X 27"/70cm	24		3811T
	2-0	Brown	1 X 36"/90cm	36		923H
	0	Brown	8 X 18"/45cm	12	CR	CC41G
	0	Brown	1 x 27"/70cm	36		812H
	0	Brown	3 x 27"/70cm	24		3812T
	0	Brown	1 X 36"/90cm	36		924H
	1	Brown	8 X 18"/45cm	12	CR	CC40G
	1	Brown	1 x 27"/70cm	36		813H
	1	Brown	3 x 27"/70cm	12		3813G
	1	Brown	1 X 36"/90cm	36		925H
2	Brown	1 x 27"/70cm	36		814H	
 <p>MH 36mm 1/2 Circle</p>	3-0	Brown	1 X 27"/70cm	36		G126H
	2-0	Brown	1 X 27"/70cm	36		G127H
	0	Brown	1 X 27"/70cm	36		G128H
 <p>MO-4 36mm 1/2 Circle</p>	0	Brown	8 X 18"/45cm	12	CR	CC02G
	0	Brown	1 X 27"/70cm	36		4924H
	1	Brown	8 X 18"/45cm	12	CR	CC01G
	1	Brown	1 X 27"/70cm	36		4925H
	1	Brown	3 X 27"/70cm	24		5589T
	1	Brown	8 X 27"/70cm	12	CR	CC38G

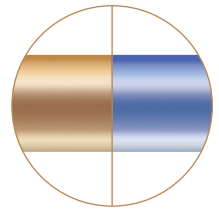

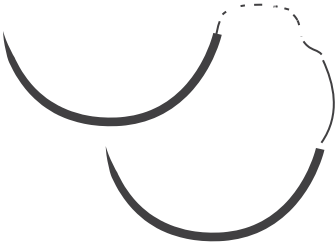

Surgical Gut Suture – Chromic

Taperpoint 

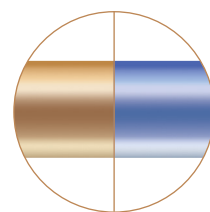
Needle	Suture USP	Color	Length	EA/BX	Special	Product Code
 CT 40mm 1/2 Circle	3-0	Brown	1 X 27"/70cm	36		800H
	3-0	Brown	1 X 36"/90cm	36		912H
	2-0	Brown	1 X 27"/70cm	36		801H
	2-0	Brown	1 X 36"/90cm	36		913H
	0	Brown	1 X 27"/70cm	36		802H
	0	Brown	1 X 36"/90cm	36		914H
	1	Brown	1 X 27"/70cm	36		803H
	1	Brown	3 X 27"/70cm	24		3803T
 CT 40mm 1/2 Circle	3-0	Brown	1 X 54"/135cm	36		990H
	2-0	Brown	1 X 54"/135cm	36		991H
 LH 40mm 1/2 Circle	2-0	Brown	1 X 27"/70cm	36		G133H
 MO-2 40mm 1/2 Circle	1	Brown	1 X 27"/70cm	36		4915H

Surgical Gut Suture – Chromic

Taperpoint 

Needle	Suture USP	Color	Length	EA/BX	Special	Product Code
 <p>CTX 48mm 1/2 Circle</p>	3-0	Brown	1 X 27"/70cm	36		862H
	2-0	Brown	1 X 27"/70cm	36		863H
	2-0	Brown	1 X 36"/90cm	36		903H
	0	Brown	1 X 27"/70cm	36		864H
	0	Brown	1 X 36"/90cm	36		904H
	1	Brown	1 X 27"/70cm	36		865H
	1	Brown	1 X 36"/90cm	36		905H
 <p>TP-1 65mm 1/2 Circle</p>	1	Brown	4 X 27"/70cm	12		M760G
	1	Brown	1 X 60"/150cm	12	Looped	GL30G
	2	Brown	1 X 60"/150cm	12	Looped	GL31G
 <p>XLH 70mm 1/2 Circle</p>	0	Brown	1 X 27"/70cm	24		44T
 <p>UR-6 26mm 5/8 Circle</p>	3-0	Brown	1 X 27"/70cm	36		N877H
	2-0	Brown	1 X 27"/70cm	36		N878H
	0	Brown	1 X 27"/70cm	36		N879H
 <p>UR-5 36mm 5/8 Circle</p>	2-0	Brown	1 X 27"/70cm	36		U245H
	0	Brown	1 X 27"/70cm	36		U246H

Surgical Gut Suture – Chromic

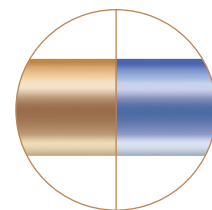

Taperpoint

Needle	Suture USP	Color	Length	EA/BX	Special	Product Code
 UR-4 40mm 5/8 Circle	2-0	Brown	1 X 27"/70cm	36		U255H
	0	Brown	1 X 27"/70cm	36		U256H
 SH,ST-1 45mm Straight	3-0	Brown	1 X 36"/90cm	36		G152H

Tapercut Cardio







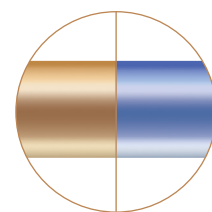

Needle	Suture USP	Color	Length	EA/BX	Special	Product Code
 V-34 36mm 1/2 Circle	3-0	Brown	1 X 36"/90cm	36		942H
	2-0	Brown	1 X 27"/70cm	36		837H
	2-0	Brown	1 X 36"/90cm	36		943H
	0	Brown	1 X 27"/70cm	36		838H
	0	Brown	1 X 36"/90cm	36		944H
	1	Brown	1 X 27"/70cm	36		839H
	1	Brown	1 X 36"/90cm	36		945H

Tapercut

Needle	Suture USP	Color	Length	EA/BX	Special	Product Code
 V-5 17mm 1/2 Circle	4-0	Brown	1 X 27"/70cm	36		U233H

Surgical Gut Suture – Chromic



Reverse Cutting 						
Needle	Suture USP	Color	Length	EA/BX	Special	Product Code
 M-2 13mm 1/4 Circle	4-0	Brown	1 X 12"/30cm	12		752G
 M-2 13mm 1/4 Circle	4-0	Brown	1 X 12"/30cm	12		751G
 C-3 13mm 3/8 Circle	5-0	Brown	1 X 12"/30cm	12		723G
 FS-2 19mm 3/8 Circle	5-0	Brown	1 X 27"/70cm	12		634G
	4-0	Brown	1 X 27"/70cm	36		635H
	3-0	Brown	1 X 27"/70cm	36		636H
 FS-1 24mm 3/8 Circle	2-0	Brown	1 X 27"/70cm	36		637H
 M-1 13mm 1/2 Circle	4-0	Brown	1 X 12"/30cm	12		744G
 J-1 17mm 1/2 Circle	4-0	Brown	1 X 18"/45cm	12		724G
	4-0	Brown	1 X 27"/70cm	36		U213H
 CP-2 26mm 1/2 Circle	3-0	Brown	1 X 27"/70cm	36		886H
	2-0	Brown	1 X 27"/70cm	36		887H

Surgical Gut Suture – Chromic

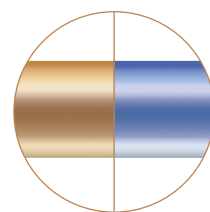

Reverse Cutting ▾









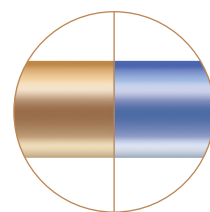







Needle	Suture USP	Color	Length	EA/BX	Special	Product Code
 CP-1 36mm 1/2 Circle	2-0	Brown	1 X 27"/70cm	36		816H
	0	Brown	1 X 27"/70cm	36		817H
	1	Brown	1 X 36"/90cm	36		975H
 CP 40mm 1/2 Circle	3-0	Brown	1 X 27"/70cm	36		832H
	2-0	Brown	1 X 27"/70cm	36		833H
	1	Brown	1 X 27"/70cm	36		805H
 KS 60mm Straight	3-0	Brown	1 X 27"/70cm	36		654H

Taperpoint ⊙, Reverse Cutting ▾

Needle	Suture USP	Color	Length	EA/BX	Special	Product Code
 CT-1, CP-1 36mm 1/2 Circle	3-0	Brown	1 X 54"/135cm	36		982H
	2-0	Brown	1 X 54"/135cm	36		983H
 CT, FSL 40mm 1/2 Circle	2-0	Brown	1 X 54"/135cm	36		977H

Surgical Gut Suture – Chromic







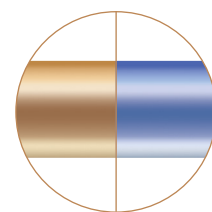



Prime Reverse Cutting 						
Needle	Suture USP	Color	Length	EA/BX	Special	Product Code
 G-6 8mm 1/4 Circle	6-0	Brown	1 X 18"/45cm	12		<u>794G</u>
	6-0	Blue	1 X 18"/45cm	12		<u>795G</u>
 G-1 11mm 3/8 Circle	6-0	Brown	1 X 18"/45cm	12		<u>796G</u>
 G-1 11mm 3/8 Circle	6-0	Brown	1 X 18"/45cm	12		<u>790G</u>
 G-3 13mm 3/8 Circle	5-0	Brown	1 X 18"/45cm	12		<u>792G</u>
	4-0	Brown	1 X 18"/45cm	12		<u>793G</u>
 P-3 13mm 3/8 Circle	5-0	Brown	1 X 18"/45cm	12		<u>687G</u>
	4-0	Brown	1 X 18"/45cm	12		<u>1654G</u>
 PS-3 16mm 3/8 Circle	6-0	Brown	1 X 18"/45cm	12		<u>1635G</u>
	5-0	Brown	1 X 18"/45cm	12		<u>1636G</u>
 PS-2 19mm 3/8 Circle	4-0	Brown	1 X 18"/45cm	12		<u>1637G</u>
	3-0	Brown	1 X 27"/70cm	36		<u>1638G</u>
	2-0	Brown	1 X 27"/70cm	36		<u>1621H</u>
 PS 26mm 3/8 Circle	0	Brown	1 X 27"/70cm	36		<u>598H</u>

Surgical Gut Suture – Chromic



Prime Reverse Cutting

Needle	Suture USP	Color	Length	EA/BX	Special	Product Code
 G-2 8mm 1/2 Circle	4-0	Brown	1 X 18"/45cm	12		<u>798G</u>
 P-2 8mm 1/2 Circle	5-0	Brown	1 X 18"/45cm	12		<u>1658G</u>
	4-0	Brown	1 X 18"/45cm	12		<u>1659G</u>
 PS-6 10mm 1/2 Circle	6-0	Brown	1 X 18"/45cm	12		<u>1816G</u>
 PS-5 13mm 1/2 Circle	5-0	Brown	1 X 18"/45cm	12		<u>1652G</u>
	4-0	Brown	1 X 18"/45cm	12		<u>1653G</u>
 PS-4 16mm 1/2 Circle	6-0	Brown	1 X 18"/45cm	12		<u>1641G</u>
	5-0	Brown	1 X 18"/45cm	12		<u>1642G</u>
	4-0	Brown	1 X 18"/45cm	12		<u>1643G</u>
 PS-4C 16mm Compound Curve	4-0	Brown	1 X 18"/45cm	12		<u>2644G</u>
	3-0	Brown	1 X 18"/45cm	12		<u>2643G</u>



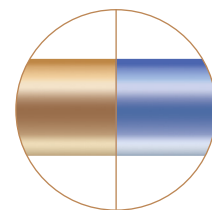

Conventional Cutting

Needle	Suture USP	Color	Length	EA/BX	Special	Product Code
 CR-1 22mm 3/8 Circle	4-0	Brown	1 X 18"/45cm	36		<u>C101H</u>

Surgical Gut Suture – Chromic



Spatula Reverse Cutting

Needle	Suture USP	Color	Length	EA/BX	Special	Product Code
 TG100-8 6.5mm 1/4 Circle	6-0	White	1 X 18"/45cm	12		1744G
 S-14 8mm 1/4 Circle	6-0	Blue	1 X 18"/45cm	12		1791G
	5-0	Brown	1 X 12"/30cm	12		1766G
	5-0	Brown	1 X 18"/45cm	12		1792G
 S-4 8mm 1/4 Circle	4-0	Brown	1 X 18"/45cm	12		1793G
 TG140-8 6.5mm 3/8 Circle	7-0	Blue	1 X 18"/45cm	12		1797G
	6-0	Blue	1 X 18"/45cm	12		1731G
 S-2 8mm 1/2 Circle	4-0	Brown	1 X 18"/45cm	12		1798G

Ultima Reverse Cutting

Needle	Suture USP	Color	Length	EA/BX	Special	Product Code
 CS175-8 7mm 1/2 Circle	7-0	Brown	1 X 18"/45cm	12		1745G

Surgical Gut Suture – Chromic

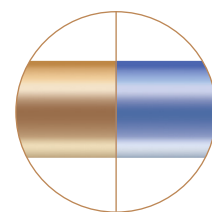

Ligapak Reel

Needle	Suture USP	Color	Length	EA/BX	Special	Product Code
	4-0	Brown	1 X 54"/135cm	12		L111G
	3-0	Brown	1 X 54"/135cm	12		L112G
	2-0	Brown	1 X 54"/135cm	12		L113G
	0	Brown	1 X 54"/135cm	12		L114G
	1	Brown	1 X 54"/135cm	12		L115G

No Needle

Needle	Suture USP	Color	Length	EA/BX	Special	Product Code
	4-0	Brown	1 X 54"/135cm	36		S111H
	3-0	Brown	1 X 54"/135cm	36		S112H
	2-0	Brown	12 X 18"/45cm	24		SG13T
	2-0	Brown	1 X 54"/135cm	36		S113H
	0	Brown	12 X 18"/45cm	24		SG14T
	0	Brown	1 X 54"/135cm	36		S114H
	1	Brown	12 X 18"/45cm	24		SG15T
	1	Brown	1 X 54"/135cm	24		S115H
	2	Brown	1 X 54"/135cm	36		S116H
	3	Brown	1 X 54"/135cm	36		S117H

General Information	Needle Index	True-to-Scale Needle Diagram	Suturing	Knotless Tissue Control Devices	Sutures: Plus Antibacterial
Sutures: Absorbable	Sutures: Nonabsorbable				

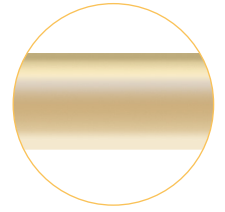

Surgical Gut Suture – Plain







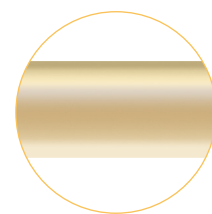

Surgical gut suture is an absorbable, sterile surgical suture composed of purified connective tissue (mostly collagen) derived from either the serosal layer of beef (bovine) or the submucosal fibrous layer of sheep (ovine) intestines. Surgical gut sutures are available in plain or chromic.¹

Surgical gut suture is indicated for use in general soft tissue approximation and/or ligation, including use in ophthalmic procedures, but not for use in cardiovascular and neurological tissues.¹



Surgical Gut Suture – Plain



Taperpoint 						
Needle	Suture USP	Color	Length	EA/BX	Special	Product Code
 RB-1 17mm 1/2 Circle	4-0	Yellowish Tan	1 X 27"/70cm	36		U207H
 CT-3 22mm 1/2 Circle	3-0	Yellowish Tan	1 X 27"/70cm	36		N862H
	2-0	Yellowish Tan	1 X 27"/70cm	36		N863H
	0	Yellowish Tan	1 X 27"/70cm	36		N864H
 SH 26mm 1/2 Circle	4-0	Yellowish Tan	1 X 27"/70cm	36		G321H
	3-0	Yellowish Tan	1 X 27"/70cm	36		G322H
 CT-1 36mm 1/2 Circle	3-0	Yellowish Tan	3 X 18"/45cm	24		5503T
	3-0	Yellowish Tan	1 X 27"/70cm	36		842H
	2-0	Yellowish Tan	1 X 27"/70cm	36		843H
	0	Yellowish Tan	1 X 27"/70cm	36		844H
 CT 40mm 1/2 Circle	3-0	Yellowish Tan	8 X 18"/45cm	12	CR	CP53G
	3-0	Yellowish Tan	1 X 27"/70cm	36		852H
	2-0	Yellowish Tan	1 X 27"/70cm	36		853H
 CTX 48mm 1/2 Circle	3-0	Yellowish Tan	1 X 27"/70cm	36		873H
	2-0	Yellowish Tan	1 X 27"/70cm	36		872H
 XLH 70mm 1/2 Circle	3-0	Yellowish Tan	1 X 27"/70cm	24		52T
	2-0	Yellowish Tan	1 X 27"/70cm	24		53T

Surgical Gut Suture – Plain

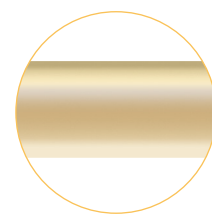
Tapercut Cardio 

Needle	Suture USP	Color	Length	EA/BX	Special	Product Code
 V-7 26mm 1/2 Circle	3-0	Yellowish Tan	1 X 18"/45cm	12		849G
 V-34 36mm 1/2 Circle	3-0	Yellowish Tan	1 X 27"/70cm	36		846H



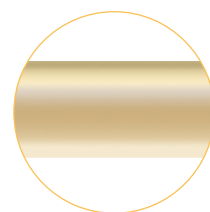

Reverse Cutting 

Needle	Suture USP	Color	Length	EA/BX	Special	Product Code
 FS-2 19mm 3/8 Circle	5-0	Yellowish Tan	1 X 27"/70cm	12		H820G
	4-0	Yellowish Tan	1 X 27"/70cm	36		H821H
	3-0	Yellowish Tan	1 X 27"/70cm	36		H822H
 FS-1 24mm 3/8 Circle	3-0	Yellowish Tan	1 X 27"/70cm	36		H810H
	2-0	Yellowish Tan	1 X 27"/70cm	36		H823H
 M-1 13mm 1/2 Circle	4-0	Yellowish Tan	1 X 12"/30cm	12		742G
 X-1 22mm 1/2 Circle	3-0	Yellowish Tan	1 X 18"/45cm	12		612G

Surgical Gut Suture – Plain

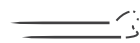

Reverse Cutting









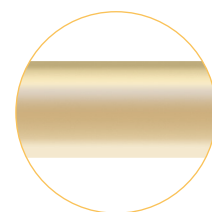





Needle	Suture USP	Color	Length	EA/BX	Special	Product Code
 CP-1 36mm 1/2 Circle	2-0	Yellowish Tan	1 X 27"/70cm	36		898H
 SC-1 13mm Straight	4-0	Yellowish Tan	1 X 18"/45cm	36		1824H
 SC-1 13mm Straight	4-0	Yellowish Tan	1 X 18"/45cm	36		1828H
 KS 60mm Straight	3-0	Yellowish Tan	1 X 27"/70cm	36		665H

Prime Reverse Cutting

Needle	Suture USP	Color	Length	EA/BX	Special	Product Code
 G-6 8mm 1/4 Circle	6-0	Yellowish Tan	1 X 18"/45cm	12		775G
 G-1 11mm 3/8 Circle	6-0	Yellowish Tan	1 X 18"/45cm	12		774G
 G-1 11mm 3/8 Circle	6-0	Yellowish Tan	1 X 18"/45cm	12		770G
 P-1 11mm 3/8 Circle	6-0	Yellowish Tan	1 X 18"/45cm	12		1657G

Surgical Gut Suture – Plain

Prime Reverse Cutting 

Needle	Suture USP	Color	Length	EA/BX	Special	Product Code
 G-3 13mm 3/8 Circle	5-0	Yellowish Tan	1 X 18"/45cm	12		<u>772G</u>
	4-0	Yellowish Tan	1 X 18"/45cm	12		<u>773G</u>
 P-3 13mm 3/8 Circle	5-0	Yellowish Tan	1 X 18"/45cm	12		<u>688G</u>
	4-0	Yellowish Tan	1 X 18"/45cm	12		<u>1644G</u>
 PS-3 16mm 3/8 Circle	5-0	Yellowish Tan	1 X 18"/45cm	12		<u>1626G</u>
 PS-2 19mm 3/8 Circle	4-0	Yellowish Tan	1 X 18"/45cm	36		<u>1627G</u>
	3-0	Yellowish Tan	1 X 27"/70cm	36		<u>1630H</u>
 PS-1 24mm 3/8 Circle	3-0	Yellowish Tan	1 X 27"/70cm	36		<u>1640H</u>
 P-2 8mm 1/2 Circle	5-0	Yellowish Tan	1 X 18"/45cm	12		<u>658G</u>
 PS-4 16mm 1/2 Circle	5-0	Yellowish Tan	1 X 18"/45cm	12		<u>1632G</u>
	4-0	Yellowish Tan	1 X 18"/45cm	12		<u>1633G</u>

Prime Conventional Cutting 

Needle	Suture USP	Color	Length	EA/BX	Special	Product Code
 PC-1 13mm 3/8 Circle	6-0	Yellowish Tan	1 X 18"/45cm	12		<u>1916G*</u>
	5-0	Yellowish Tan	1 X 18"/45cm	12		<u>1915G*</u>

Surgical Gut Suture – Plain

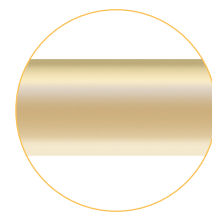

Spatula Reverse Cutting

Needle	Suture USP	Color	Length	EA/BX	Special	Product Code
 S-14 8mm 1/4 Circle	5-0	Yellowish Tan	1 X 12"/30cm	12		1775G
	5-0	Yellowish Tan	1 X 18"/45cm	12		1772G
 TG140-8 6.5mm 3/8 Circle	6-0	Yellowish Tan	1 X 18"/45cm	12		1735G

Ligapak Reel

Needle	Suture USP	Color	Length	EA/BX	Special	Product Code
	4-0	Yellowish Tan	1 X 54"/135cm	12		L101G
	3-0	Yellowish Tan	1 X 54"/135cm	12		L102G
	2-0	Yellowish Tan	1 X 54"/135cm	12		L103G
	0	Yellowish Tan	1 X 54"/135cm	12		L104G

Needle	Suture USP	Color	Length	EA/BX	Special	Product Code
	3-0	Yellowish Tan	12 X 18"/45cm	24		SG2T
	3-0	Yellowish Tan	1 X 54"/135cm	36		S102H
	2-0	Yellowish Tan	1 X 54"/135cm	36		S103H
	0	Yellowish Tan	1 X 54"/135cm	36		S104H
	1	Yellowish Tan	1 X 54"/135cm	36		S105H

General Information	Needle Index	True-to-Scale Needle Diagram	Suturing	Knotless Tissue Control Devices	Sutures: Plus Antibacterial
Sutures: Absorbable	Sutures: Nonabsorbable				

Sutures: Nonabsorbable



General Information	Needle Index	True-to-Scale Needle Diagram	Suturing	Knotless Tissue Control Devices	Sutures: Plus Antibacterial
Sutures: Absorbable	Sutures: Nonabsorbable				

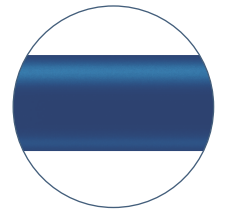

PRONOVA[®] Poly (Hexafluoropropylene - VDF) Suture

PRONOVA Suture (clear or pigmented) is a nonabsorbable, sterile surgical suture made from polymer blend of poly (vinylidene fluoride) and poly (vinylidene fluoride-co-hexafluoropropylene). The suture is pigmented blue to enhance visibility.¹









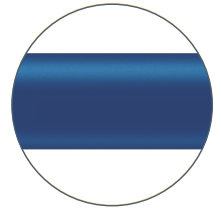







PRONOVA Suture is indicated for use in general soft tissue approximation and/or ligation, including use in cardiovascular, ophthalmic and neurological procedures.¹



General Information	Needle Index	True-to-Scale Needle Diagram	Suturing	Knotless Tissue Control Devices	Sutures: Plus Antibacterial
Sutures: Absorbable	Sutures: Nonabsorbable				

PRONOVA® Poly (Hexafluoropropylene - VDF) Suture









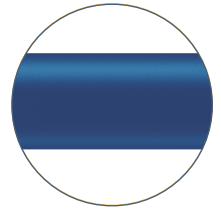

Taperpoint 						
Needle	Suture USP	Color	Length	EA/BX	Special	Product Code
 BV130-5 6.5mm 3/8 Circle	8-0	Blue	2 X 24"/60cm	12		M3739
 BV175-6 8mm 3/8 Circle	8-0	Blue	2 X 24"/60cm	12		M3743
	7-0	Blue	4 X 24"/60cm	12		M3735
	7-0	Blue	2 X 24"/60cm	12		M3737
	7-0	Blue	1 X 24"/60cm	36		3735H
 BV175-7 8mm 3/8 Circle	8-0	Blue	2 X 24"/60cm	12		M3767
	7-0	Blue	4 X 30"/75cm	12		M3770
	7-0	Blue	2 X 24"/60cm	12		M3766
	7-0	Blue	2 X 18"/45cm	12		M3768
 BV-1 9.3mm 3/8 Circle	7-0	Blue	4 X 30"/75cm	12		M3703
	7-0	Blue	1 X 30"/75cm	36		3703H
	7-0	Blue	4 X 24"/60cm	12		M3702
	7-0	Blue	1 X 24"/60cm	36		3702H
	7-0	Blue	1 X 24"/60cm	36		3304H
	7-0	Blue	1 X 18"/45cm	36		3701H
	6-0	Blue	4 X 30"/75cm	12		M3709
	6-0	Blue	1 X 30"/75cm	36		3709H
	6-0	Blue	4 X 24"/60cm	12		M3805
	6-0	Blue	1 X 24"/60cm	36		3805H
	6-0	Blue	1 X 24"/60cm	36		3305H
	6-0	Blue	1 X 18"/45cm	36		3806H

General Information	Needle Index	True-to-Scale Needle Diagram	Suturing	Knotless Tissue Control Devices	Sutures: Plus Antibacterial
Sutures: Absorbable	Sutures: Nonabsorbable				

PRONOVA® Poly (Hexafluoropropylene - VDF) Suture





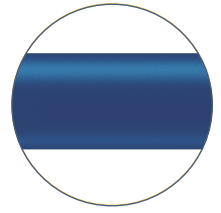

Taperpoint 						
Needle	Suture USP	Color	Length	EA/BX	Special	Product Code
 BV175-8 9.3mm 3/8 Circle	7-0	Blue	2 X 24"/60cm	12		M3747
 BV 11mm 3/8 Circle	6-0	Blue	1 X 30"/75cm	36		3776H
 C-1 13mm 3/8 Circle	6-0	Blue	4 X 30"/75cm	12		M3706
	6-0	Blue	1 X 30"/75cm	36		3706H
	6-0	Blue	1 X 30"/75cm	36		3307H
	6-0	Blue	1 X 24"/60cm	36		3726H
	5-0	Blue	4 X 36"/90cm	12		M3720
	5-0	Blue	1 X 36"/90cm	36		3720H
	5-0	Blue	1 X 36"/90cm	36		3321H
	5-0	Blue	4 X 24"/60cm	12		M3725
	5-0	Blue	1 X 24"/60cm	36		3725H
	5-0	Blue	1 X 18"/45cm	36		3717H
 BB 17mm 3/8 Circle	5-0	Blue	1 X 36"/90cm	36		3580H
	4-0	Blue	1 X 36"/90cm	36		3581H
 RB-2 13mm 1/2 Circle	6-0	Blue	1 X 30"/75cm	36		3711H
	5-0	Blue	1 X 30"/75cm	36		3710H

General Information	Needle Index	True-to-Scale Needle Diagram	Suturing	Knotless Tissue Control Devices	Sutures: Plus Antibacterial
Sutures: Absorbable	Sutures: Nonabsorbable				

PRONOVA® Poly (Hexafluoropropylene - VDF) Suture



Taperpoint 						
Needle	Suture USP	Color	Length	EA/BX	Special	Product Code
 <p>RB-1 17mm 1/2 Circle</p>	5-0	Blue	1 X 36"/90cm	36		3556H
	5-0	Blue	1 X 24"/60cm	36		3555H
	4-0	Blue	1 X 36"/90cm	36		3557H
	3-0	Blue	1 X 36"/90cm	36		3558H
 <p>SH-1 22mm 1/2 Circle</p>	4-0	Blue	1 X 30"/75cm	36		3526H
	3-0	Blue	1 X 30"/75cm	36		3762H
 <p>SH 26mm 1/2 Circle</p>	4-0	Blue	1 X 36"/90cm	36		3521H
	3-0	Blue	1 X 36"/90cm	36		3522H
	2-0	Blue	1 X 36"/90cm	36		3523H
 <p>MH 36mm 1/2 Circle</p>	3-0	Blue	1 X 36"/90cm	36		3842H

General Information	Needle Index	True-to-Scale Needle Diagram	Suturing	Knotless Tissue Control Devices	Sutures: Plus Antibacterial
Sutures: Absorbable	Sutures: Nonabsorbable				

PRONOVA® Poly (Hexafluoropropylene - VDF) Suture

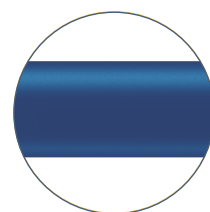

Tapercut Cardio 						
Needle	Suture USP	Color	Length	EA/BX	Special	Product Code
 CC-1 13mm 3/8 Circle	6-0	Blue	1 X 30"/75cm	36		<u>3707H</u>
 V-7 26mm 1/2 Circle	4-0	Blue	1 X 36"/90cm	36		<u>3975H</u>
	3-0	Blue	1 X 36"/90cm	36		<u>3976H</u>

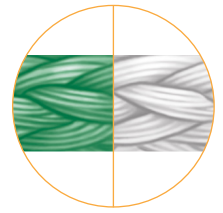

ETHIBOND EXCEL[®] Polyester Suture

ETHIBOND EXCEL Suture is a nonabsorbable, braided, sterile, surgical suture composed of Poly (ethylene terephthalate). It is prepared from fibers of high molecular weight, long-chain, linear polyesters having recurrent aromatic rings as an integral component.¹

The suture is uniformly coated with polybutylate or poly {oxy-1, 4 butanediyloxy (1, 6-dioxo-1, 6 hexanediy)}). The highly adherent coating is a relatively nonreactive nonabsorbable compound which acts as a lubricant to mechanically improve the physical properties of the uncoated suture by improving handling qualities as contrasted to the braided, uncoated fiber.¹





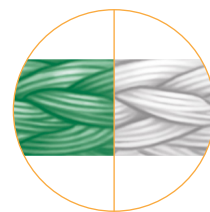

ETHIBOND EXCEL Suture is braided for optimal handling properties, and dyed green for enhanced visibility in the surgical field.¹

ETHIBOND EXCEL Suture is indicated for use in general soft tissue approximation and/or ligation, including use in cardiovascular, ophthalmic and neurological procedures.¹



ETHIBOND EXCEL® Polyester Suture







Taperpoint 

Needle	Suture USP	Color	Length	EA/BX	Special	Product Code
 BV-1 9.3mm 3/8 Circle	7-0	Green	1 X 18"/45cm	36		X701H
	7-0	Green	10 X 18"/45cm	12		10X07
	6-0	Green	1 X 24"/60cm	36		X805H
 C-1 13mm 3/8 Circle	6-0	Green	1 X 30"/75cm	36		X889H
	5-0	Green	1 X 30"/75cm	36		X890H
 C-1 13mm 3/8 Circle	6-0	Green	1 X 18"/45cm	36		X706H
	5-0	Green	1 X 18"/45cm	36		X717H
	5-0	Green	1 X 30"/75cm	36		X727H
	4-0	Green	1 X 30"/75cm	36	Pledget*	X726H
 BB 17mm 3/8 Circle	4-0	Green	1 X 30"/75cm	36		X881H
 BB 17mm 3/8 Circle	4-0	Green	1 X 30"/75cm	36		X581H
	3-0	Green	1 X 36"/90cm	36		X588H
 TF 13mm 1/2 Circle	5-0	Green	1 X 24"/60cm	36		X205H
	4-0	Green	1 X 24"/60cm	36		X204H
 UCL 13mm 1/2 Circle	2-0	Green	1 X 27"/70cm	36		X114H

General Information	Needle Index	True-to-Scale Needle Diagram	Suturing	Knotless Tissue Control Devices	Sutures: Plus Antibacterial
Sutures: Absorbable	Sutures: Nonabsorbable				

ETHIBOND EXCEL® Polyester Suture







Taperpoint 						
Needle	Suture USP	Color	Length	EA/BX	Special	Product Code
 <p>RB-1 17mm 1/2 Circle</p>	5-0	Green	1 X 30"/75cm	36		X550H
	5-0	Green	1 X 36"/90cm	36		X556H
	4-0	Green	1 X 30"/75cm	36		X551H
	4-0	Green	4 X 30"/75cm	12		MX551
	4-0	Green	1 X 36"/90cm	36		X557H
	3-0	Green	4 X 30"/75cm	12		MX552
	3-0	Green	1 X 36"/90cm	36		X558H
	2-0	Green	4 X 30"/75cm	12		MX553
	2-0	White	4 X 30"/75cm	12		MX523
	2-0	Grn/Wht	8 X 30"/75cm	12	Pledget*	PXX41
	2-0	Grn/Wht	8 X 30"/75cm	12	Pledget†	PXX43
	2-0	Grn/Wht	10 X 30"/75cm	12		10X42
	2-0	Grn/Wht	10 X 30"/75cm	12	Pledget‡	SXX43
 <p>RB-1 17mm 1/2 Circle</p>	5-0	Green	1 X 30"/75cm	36		X870H
	4-0	Green	1 X 30"/75cm	36		X871H
	3-0	Green	1 X 30"/75cm	36		X872H
	2-0	Green	1 X 30"/75cm	36		X873H
 <p>SH-2 20mm 1/2 Circle</p>	2-0	Green	1 X 30"/75cm	36	Pledget*	PX82H
	2-0	Green	1 X 30"/75cm	36		X582H
	2-0	White	1 X 30"/75cm	36	Pledget*	PX83H
	2-0	Grn/Wht	10 X 30"/75cm	12	Pledget*	PXX80
	2-0	Grn/Wht	10 X 30"/75cm	12		PXX82
	2-0	Grn/Wht	10 X 30"/75cm	12	Pledget§	SXP82
	2-0	Green	1 X 36"/90cm	36		X559H
 <p>MO-7 22mm 1/2 Circle</p>	2-0	Green	8 X 18"/45cm	12		CX42D
	0	Green	8 X 18"/45cm	12		CX41D

*7mm x 3mm x 1.5mm Firm TFE Polymer Pledget
†3mm x 3mm x 1.5mm Firm TFE Polymer Pledget
‡3mm x 3mm x 1.5mm Soft TFE Polymer Pledget
§7mm x 3mm x 1.5mm Soft TFE Polymer Pledget
|| Safety organizer tray

General Information	Needle Index	True-to-Scale Needle Diagram	Suturing	Knotless Tissue Control Devices	Sutures: Plus Antibacterial
Sutures: Absorbable	Sutures: Nonabsorbable				

ETHIBOND EXCEL® Polyester Suture







Taperpoint 						
Needle	Suture USP	Color	Length	EA/BX	Special	Product Code
 <p>SH-1 22mm 1/2 Circle</p>	4-0	Green	1 X 36"/90cm	36		X761H
	3-0	Green	1 X 36"/90cm	36		X762H
	2-0	Green	4 X 30"/75cm	12		MX763
	2-0	Grn/Wht	10 X 30"/75cm	12	Pledget*	PXX92
	2-0	Green	1 X 36"/90cm	36		X763H
 <p>CT-2 26mm 1/2 Circle</p>	2-0	Green	8 X 18"/45cm	12	CR	CX26D†
	2-0	Green	1 X 30"/75cm	36		X411H
	0	Green	8 X 18"/45cm	12	CR	CX27D†
	0	Green	1 X 30"/75cm	36		X412H
 <p>MO-6 26mm 1/2 Circle</p>	2-0	Green	8 X 18"/45cm	12	CR	CX46D†
	0	Green	8 X 18"/45cm	12	CR	CX45D†
 <p>SH 26mm 1/2 Circle</p>	4-0	Green	8 X 18"/45cm	12	CR	CX14D†
	4-0	Green	1 X 30"/75cm	36		X831H
	3-0	Green	8 X 18"/45cm	12	CR	CX13D†
	3-0	Green	1 X 30"/75cm	36		X832H
	2-0	Green	8 X 18"/45cm	12	CR	CX12D†
	2-0	Green	1 X 30"/75cm	36		X833H
	2-0	Green	4 X 30"/75cm	12		MX833
	2-0	White	4 X 30"/75cm	12		MX823
	0	Green	1 X 30"/75cm	36		X834H

*7mm x 3mm x 15mm Firm TFE Polymer Pledget
† Safety organizer tray

General Information	Needle Index	True-to-Scale Needle Diagram	Suturing	Knotless Tissue Control Devices	Sutures: Plus Antibacterial
Sutures: Absorbable	Sutures: Nonabsorbable				

ETHIBOND EXCEL® Polyester Suture





Taperpoint 						
Needle	Suture USP	Color	Length	EA/BX	Special	Product Code
 <p>SH 26mm 1/2 Circle</p>	4-0	Green	1 X 36"/90cm	36		X521H
	3-0	Green	1 X 30"/75cm	36		X562H
	3-0	Green	1 X 36"/90cm	36		X522H
	2-0	Green	1 X 30"/75cm	36		X563H
	2-0	Green	4 X 30"/75cm	12		MX563
	2-0	Grn/Wht	10 X 30"/75cm	12		10X82
	2-0	Grn/Wht	10 X 30"/75cm	12	Pledget*	PXX76
	2-0	Grn/Wht	10 X 30"/75cm	12	Pledget*	SXP76
	2-0	Grn/Wht	10 X 30"/75cm	12	Pledget†	SXX86
	2-0	Green	1 X 36"/90cm	12	Pledget*	PX514
	2-0	Green	1 X 36"/90cm	36	Pledget*	SXP02
	2-0	Green	1 X 36"/90cm	36		X523H
	2-0	White	1 X 36"/90cm	36		X513H
	2-0	Grn/Wht	6 X 36"/90cm	12	Pledget*	PXX85
	2-0	Grn/Wht	10 X 36"/90cm	12		10X86
	2-0	Grn/Wht	10 X 36"/90cm	12	Pledget*	PXX86
	2-0	Grn/Wht	10 X 36"/90cm	12	Pledget*	SXP86
	0	Grn/Wht	10 X 30"/75cm	12	Pledget*	PXX87
0	Green	1 X 36"/90cm	36		X524H	
 <p>CT-1 36mm 1/2 Circle</p>	2-0	Green	8 X 18"/45cm	12	CR	CX22D‡
	2-0	Green	1 X 30"/75cm	36		X423H
	0	Green	8 X 18"/45cm	12	CR	CX21D‡
	0	Green	1 X 30"/75cm	36		X424H
	1	Green	1 X 30"/75cm	36		X425H
 <p>MH 36mm 1/2 Circle</p>	2-0	Green	1 X 36"/90cm	36		X843H
	0	Green	1 X 36"/90cm	36		X844H



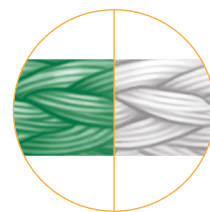

*7mm x 3mm x 15mm Firm TFE Polymer Pledget
†3mm x 3mm x 15mm Firm TFE Polymer Pledget
‡ Safety organizer tray

General Information	Needle Index	True-to-Scale Needle Diagram	Suturing	Knotless Tissue Control Devices	Sutures: Plus Antibacterial
Sutures: Absorbable	Sutures: Nonabsorbable				

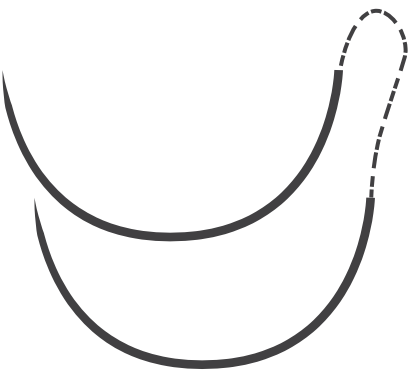
ETHIBOND EXCEL® Polyester Suture







Taperpoint 						
Needle	Suture USP	Color	Length	EA/BX	Special	Product Code
 <p>CTX 48mm 1/2 Circle</p>	0	Green	8 X 18"/45cm	12	CR	<u>CX31D*</u>
	0	Green	1 X 30"/75cm	36		<u>X864H</u>
	1	Green	8 X 18"/45cm	12	CR	<u>CX30D*</u>
	1	Green	1 X 30"/75cm	36		<u>X865H</u>
 <p>XLH 70mm 1/2 Circle</p>	1	Green	1 X 30"/75cm	12		<u>X190G</u>



Tapercut Cardio 						
Needle	Suture USP	Color	Length	EA/BX	Special	Product Code
 <p>CC-1 13mm 3/8 Circle</p>	5-0	Green	1 X 30"/75cm	36		<u>X728H</u>
 <p>V-4 17mm 3/8 Circle</p>	4-0	Green	1 X 30"/75cm	36		<u>X942H</u>

General Information	Needle Index	True-to-Scale Needle Diagram	Suturing	Knotless Tissue Control Devices	Sutures: Plus Antibacterial
Sutures: Absorbable	Sutures: Nonabsorbable				

ETHIBOND EXCEL® Polyester Suture



Tapercut Cardio 						
Needle	Suture USP	Color	Length	EA/BX	Special	Product Code
 V-4 17mm 3/8 Circle	4-0	Green	1 X 30"/75cm	36		X925H
	3-0	Green	1 X 30"/75cm	36		X926H
	2-0	Green	1 X 30"/75cm	36		X927H
	2-0	Green	4 X 30"/75cm	12		MX927
	2-0	White	4 X 30"/75cm	12		MX944
	2-0	Grn/Wht	10 X 30"/75cm	12	Pledget*	PXX22
	2-0	Grn/Wht	10 X 30"/75cm	12	Pledget*	SXP22
 V-7 26mm 1/2 Circle	3-0	Green	1 X 30"/75cm	36		X963H
	2-0	Green	1 X 30"/75cm	36		X964H
 V-34 36mm 1/2 Circle	0	Green	1 X 30"/75cm	36		X444H
 V-40 48mm 1/2 Circle	5	Green	4 X 30"/75cm	12		MB46G



Tapercut 						
Needle	Suture USP	Color	Length	EA/BX	Special	Product Code
 V-5 17mm 1/2 Circle	5-0	Green	1 X 30"/75cm	36		X951H

*7mm x 3mm x 1.5mm Firm TFE Polymer Pledget

General Information	Needle Index	True-to-Scale Needle Diagram	Suturing	Knotless Tissue Control Devices	Sutures: Plus Antibacterial
Sutures: Absorbable	Sutures: Nonabsorbable				

ETHIBOND EXCEL® Polyester Suture





Tapercut 						
Needle	Suture USP	Color	Length	EA/BX	Special	Product Code
 <p>V-5 17mm 1/2 Circle</p>	5-0	Green	1 X 30"/75cm	36		X934H
	4-0	Green	1 X 30"/75cm	36		X935H
	3-0	Green	1 X 30"/75cm	36		X936H
	3-0	White	1 X 30"/75cm	36		X916H
	3-0	Grn/Wht	8 X 30"/75cm	12	Pledget†	SXX53
	3-0	Grn/Wht	10 X 30"/75cm	12		10X53
	3-0	Green	1 X 36"/90cm	36		X806H
	2-0	Green	1 X 30"/75cm	36	Pledget*	PX937
	2-0	Green	1 X 30"/75cm	36		X937H
	2-0	White	1 X 30"/75cm	36		X917H
	2-0	Green	4 X 30"/75cm	12	Pledget*	MPX37
	2-0	White	4 X 30"/75cm	12	Pledget*	MPX17
	2-0	Grn/Wht	8 X 30"/75cm	12	Pledget*	PXX50
	2-0	Grn/Wht	8 X 30"/75cm	12	Pledget†	SXX50
	2-0	Grn/Wht	10 X 30"/75cm	12	Pledget*	PXX52
	2-0	Grn/Wht	10 X 30"/75cm	12	Pledget*	SXP52
	2-0	Grn/Wht	10 X 30"/75cm	12		10X52
	2-0	Grn/Wht	10 X 30"/75cm	12	Pledget†	SXP54
	2-0	Grn/Wht	10 X 30"/75cm	12	Pledget†	SXX54
	2-0	Green	1 X 36"/90cm	36	Pledget*	SX54H
2-0	Green	1 X 36"/90cm	36	Pledget*	PX54H	
2-0	Green	1 X 36"/90cm	36		X807H	
2-0	White	1 X 36"/90cm	36	Pledget†	SX17H	
2-0	White	1 X 36"/90cm	36	Pledget*	PX17H	
 <p>V-7 26mm 1/2 Circle</p>	4-0	Green	1 X 30"/75cm	36		X975H
	3-0	Green	1 X 30"/75cm	36		X976H
	2-0	Green	1 X 30"/75cm	36	Pledget*	PX977
	2-0	Green	1 X 30"/75cm	36	Pledget*	SXP07
	2-0	Green	1 X 30"/75cm	36		X977H
	2-0	White	1 X 30"/75cm	36		X987H
	2-0	Green	4 X 30"/75cm	12		MX977

*7mm x 3mm x 1.5mm Firm TFE Polymer Pledget
†3mm x 3mm x 1.5mm Firm TFE Polymer Pledget



General Information	Needle Index	True-to-Scale Needle Diagram	Suturing	Knotless Tissue Control Devices	Sutures: Plus Antibacterial
Sutures: Absorbable	Sutures: Nonabsorbable				

ETHIBOND EXCEL® Polyester Suture



Tapercut 						
Needle	Suture USP	Color	Length	EA/BX	Special	Product Code
 <p>V-7 26mm 1/2 Circle</p>	2-0	Grn/Wht	10 X 30"/75cm	12	Pledget*	PXX77
	2-0	Grn/Wht	10 X 30"/75cm	12	Pledget*	SXP77
	2-0	Grn/Wht	10 X 30"/75cm	12		10X72
	2-0	Green	1 X 36"/90cm	36	Pledget*	PX62H
	2-0	Green	1 X 36"/90cm	36		X966H
	2-0	White	1 X 36"/90cm	36	Pledget*	PX64H
	2-0	Grn/Wht	8 X 36"/90cm	12	Pledget*	PXX79
	2-0	Grn/Wht	10 X 36"/90cm	12		10X66
	0	Green	1 X 36"/90cm	36		X905H
	0	White	1 X 36"/90cm	36	Pledget*	PX65H
 <p>V-37 40mm 1/2 Circle</p>	2	Green	4 X 30"/75cm	12		MX69G
	5	Green	4 X 30"/75cm	12		MB66G

Trocar						
Needle	Suture USP	Color	Length	EA/BX	Special	Product Code
STP-10 250mm Straight	2-0	Green	1 X 27"/70cm	12		X997G





Reverse Cutting 						
Needle	Suture USP	Color	Length	EA/BX	Special	Product Code
 <p>FS-2 19mm 3/8 Circle</p>	4-0	Green	1 X 18"/45cm	12		X683G

*7mm x 3mm x 1.5mm Firm TFE Polymer Pledget

General Information	Needle Index	True-to-Scale Needle Diagram	Suturing	Knotless Tissue Control Devices	Sutures: Plus Antibacterial
Sutures: Absorbable	Sutures: Nonabsorbable				

ETHIBOND EXCEL® Polyester Suture

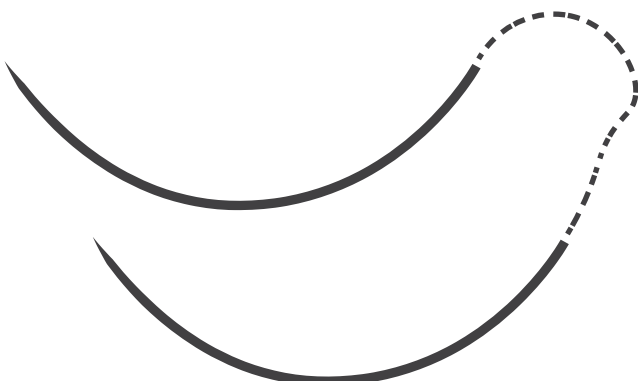













Reverse Cutting ▾						
Needle	Suture USP	Color	Length	EA/BX	Special	Product Code
 FS-1 24mm 3/8 Circle	3-0	Green	1 X 18"/45cm	36		<u>X663H</u>
 FS 26mm 3/8 Circle	2-0	Green	1 X 18"/45cm	36		<u>X664H</u>
 LR 75mm 3/8 Circle	2	Green	1 X 20"/50cm	24		<u>X406T</u>
	5	Green	1 X 20"/50cm	24		<u>B409T</u>
 LR 75mm 3/8 Circle	2	Green	1 X 30"/75cm	24		<u>X496T</u>
	5	Green	1 X 30"/75cm	24		<u>B499T</u>
 OS-2 17mm 1/2 Circle	0	Green	3 X 18"/45cm	24	CR	<u>CX74T</u>
	1	Green	3 X 18"/45cm	24	CR	<u>CX75T</u>
 OS-4 22mm 1/2 Circle	0	Green	1 X 30"/75cm	36		<u>X517H</u>
	1	Green	1 X 30"/75cm	36		<u>X518H</u>
	2	Green	1 X 30"/75cm	36		<u>X519H</u>

General Information	Needle Index	True-to-Scale Needle Diagram	Suturing	Knotless Tissue Control Devices	Sutures: Plus Antibacterial
Sutures: Absorbable	Sutures: Nonabsorbable				

ETHIBOND EXCEL® Polyester Suture





Reverse Cutting ▾						
Needle	Suture USP	Color	Length	EA/BX	Special	Product Code
 OS-6 36mm 1/2 Circle	1	Green	1 X 30"/75cm	36		X538H
 OS-8 40mm 1/2 Circle	1	Green	1 X 30"/75cm	36		X548H
 KS 60mm Straight	3-0	Green	1 X 30"/75cm	36		X622H

Prime Reverse Cutting ▾						
Needle	Suture USP	Color	Length	EA/BX	Special	Product Code
 P-1 11mm 3/8 Circle	6-0	Green	1 X 18"/45cm	12		X697G
 P-3 13mm 3/8 Circle	5-0	Green	1 X 18"/45cm	12		X698G
 PS-3 16mm 3/8 Circle	5-0	Green	1 X 18"/45cm	12		X681G
 PS-2 19mm 3/8 Circle	4-0	White	1 X 18"/45cm	12		X692G
 PS-4 16mm 1/2 Circle	4-0	White	1 X 18"/45cm	12		X695G

General Information	Needle Index	True-to-Scale Needle Diagram	Suturing	Knotless Tissue Control Devices	Sutures: Plus Antibacterial
Sutures: Absorbable	Sutures: Nonabsorbable				

ETHIBOND EXCEL® Polyester Suture



Cutting Edge Conventional 						
Needle	Suture USP	Color	Length	EA/BX	Special	Product Code
 <p>CCS 48mm 1/2 Circle</p>	5	Green	4 X 30"/75cm	12		<u>MB47G</u>

No Needle						
Needle	Suture USP	Color	Length	EA/BX	Special	Product Code
	5-0	Green	12 X 18"/45cm	36		<u>X182H</u>
	4-0	Green	12 X 18"/45cm	36		<u>X183H</u>
	4-0	Green	12 X 30"/75cm	36		<u>X303H</u>
	3-0	Green	12 X 18"/45cm	36		<u>X184H</u>
	3-0	Green	12 X 30"/75cm	36		<u>X304H</u>
	2-0	Green	12 X 18"/45cm	36		<u>X185H</u>
	2-0	Green	12 X 30"/75cm	36		<u>X305H</u>
	0	Green	6 X 18"/45cm	36		<u>X186H</u>
	0	Green	6 X 30"/75cm	36		<u>X306H</u>

General Information	Needle Index	True-to-Scale Needle Diagram	Suturing	Knotless Tissue Control Devices	Sutures: Plus Antibacterial
Sutures: Absorbable	Sutures: Nonabsorbable				

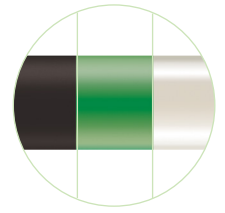

ETHILON® Nylon Suture

ETHILON Suture is nonabsorbable, sterile surgical monofilament suture composed of the long-chain aliphatic polymers Nylon 6 and Nylon 6,6. ETHILON Suture is dyed black or green to enhance visibility in tissue.¹









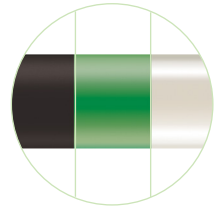







ETHILON Suture is indicated for use in general soft tissue approximation and/or ligation, including use in cardiovascular, ophthalmic, and neurological procedures.¹



General Information	Needle Index	True-to-Scale Needle Diagram	Suturing	Knotless Tissue Control Devices	Sutures: Plus Antibacterial
Sutures: Absorbable	Sutures: Nonabsorbable				

ETHILON® Nylon Suture







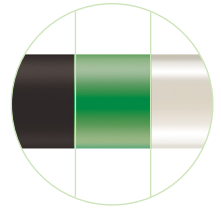

Taperpoint						
Needle	Suture USP	Color	Length	EA/BX	Special	Product Code
 BV130-3 3.8mm 3/8 Circle	10-0	Black	1 X 5"/13cm	12		2820G
	9-0	Black	1 X 5"/13cm	12		2819G
	8-0	Black	1 X 5"/13cm	12		2822G
 BV50-3 3.8mm 3/8 Circle	11-0	Black	1 X 5"/13cm	12		2881G
 BV75-3 3.8mm 3/8 Circle	10-0	Black	1 X 5"/13cm	12		2870G
 BV130-4 5mm 3/8 Circle	9-0	Black	1 X 5"/13cm	12		2813G
	8-0	Black	1 X 5"/13cm	12		2815G
 BV100-4 5.1mm 3/8 Circle	10-0	Black	1 X 5"/13cm	12		2830G
	9-0	Black	1 X 5"/13cm	12		2829G
 BV75-4 5.1mm 3/8 Circle	10-0	Black	1 X 5"/13cm	12		2850G
 BV130-5 6.5mm 3/8 Circle	10-0	Black	1 X 5"/13cm	12		2810G
	9-0	Black	1 X 5"/13cm	12		2809G
	8-0	Black	1 X 5"/13cm	12		2808G
 BV130-5 6.5mm 3/8 Circle	9-0	Black	1 X 10"/25cm	12		2800G
 BVH100-3 4.7mm 1/2 Circle	10-0	Black	1 X 5"/13cm	12		2860G
 CT 40mm 1/2 Circle	0	Black	1 X 96"/244cm	24	Looped	L886T



General Information	Needle Index	True-to-Scale Needle Diagram	Suturing	Knotless Tissue Control Devices	Sutures: Plus Antibacterial
Sutures: Absorbable	Sutures: Nonabsorbable				

ETHILON® Nylon Suture



Taperpoint 						
Needle	Suture USP	Color	Length	EA/BX	Special	Product Code
 CTX 48mm 1/2 Circle	1	Black	1 X 30"/75cm	36		830H
 TP-1 65mm 1/2 Circle	0	Black	1 X 96"/244cm	12	Looped	L880G
	1	Black	1 X 60"/150cm	12		824G
	2	Black	1 X 60"/150cm	12		825G
 ST100-3 3mm Straight	10-0	Black	1 X 5"/13cm	12		2849G







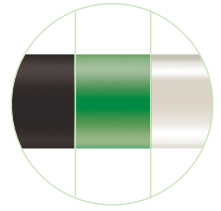

Tapercut Cardio 						
Needle	Suture USP	Color	Length	EA/BX	Special	Product Code
 V100-3 3.5mm 1/4 Circle	9-0	Black	1 X 5"/13cm	12		2894G
 V130-3 3.5mm 1/4 Circle	9-0	Black	1 X 5"/13cm	12		2898G
	8-0	Black	1 X 5"/13cm	12		2897G
 V75-3 3.5mm 1/4 Circle	10-0	Black	1 X 5"/13cm	12		2892G

Reverse Cutting 						
Needle	Suture USP	Color	Length	EA/BX	Special	Product Code
 C-2 13mm 3/8 Circle	6-0	Black	1 X 18"/45cm	12		667G

General Information	Needle Index	True-to-Scale Needle Diagram	Suturing	Knotless Tissue Control Devices	Sutures: Plus Antibacterial
Sutures: Absorbable	Sutures: Nonabsorbable				

ETHILON® Nylon Suture



Reverse Cutting ▾						
Needle	Suture USP	Color	Length	EA/BX	Special	Product Code
 VAS100-4 5mm 3/8 Circle	9-0	Black	1 X 6"/15cm	12		2890G
 C-3 13mm 3/8 Circle	5-0	Black	1 X 18"/45cm	12		668G
 FS-2 19mm 3/8 Circle	5-0	Black	1 X 18"/45cm	12		661G
	5-0	Black	1 X 18"/45cm	36		661H
	4-0	Black	1 X 18"/45cm	12		662G
	4-0	Black	1 X 18"/45cm	36		662H
 FS-1 24mm 3/8 Circle	4-0	Black	1 X 18"/45cm	36		1629H
	3-0	Black	1 X 18"/45cm	12		663G
	3-0	Black	1 X 18"/45cm	36		663H
	3-0	Black	1 X 30"/75cm	36		669H
 FS 26mm 3/8 Circle	2-0	Black	1 X 18"/45cm	12		664G
	2-0	Black	1 X 18"/45cm	36		664H
 FSL 30mm 3/8 Circle	4-0	Black	1 X 30"/75cm	36		1670H
	3-0	Black	1 X 30"/75cm	36		1671H
 PSL 30mm 3/8 Circle	4-0	Black	1 X 30"/75cm	36		562H
	3-0	Black	1 X 30"/75cm	36		1691H
 FSLX 30mm 3/8 Circle	3-0	Black	1 X 30"/75cm	36		1673H
	2-0	Black	1 X 30"/75cm	36		1674H
 PSLX 36mm 3/8 Circle	3-0	Black	1 X 30"/75cm	36		1683H
	2-0	Black	1 X 30"/75cm	36		1697H

General Information	Needle Index	True-to-Scale Needle Diagram	Suturing	Knotless Tissue Control Devices	Sutures: Plus Antibacterial
Sutures: Absorbable	Sutures: Nonabsorbable				

ETHILON® Nylon Suture

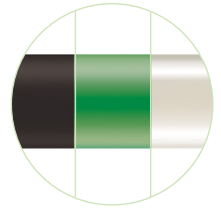









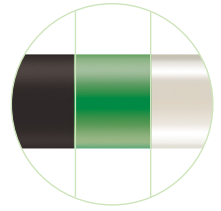



















Reverse Cutting ▾						
Needle	Suture USP	Color	Length	EA/BX	Special	Product Code
 LR 75mm 3/8 Circle	2	Black	1 X 20"/50cm	12		<u>470G*</u>
	2	Black	1 X 20"/50cm	24		<u>460T</u>
 LR 75mm 3/8 Circle	1	Black	1 X 30"/75cm	24		<u>489T</u>
	2	Black	1 X 30"/75cm	24		<u>490T</u>
 TG160-4 5.3mm 1/2 Circle	10-0	Black	1 X 12"/30cm	12		<u>7707G</u>
 X-1 22mm 1/2 Circle	3-0	Black	1 X 18"/45cm	12		<u>642G</u>
 KS 60mm Straight	4-0	Black	1 X 30"/75cm	36		<u>626H</u>
	3-0	Black	1 X 30"/75cm	36		<u>627H</u>
	2-0	Black	1 X 30"/75cm	36		<u>628H</u>

*Lead shot and bolster

General Information	Needle Index	True-to-Scale Needle Diagram	Suturing	Knotless Tissue Control Devices	Sutures: Plus Antibacterial
Sutures: Absorbable	Sutures: Nonabsorbable				

ETHILON® Nylon Suture









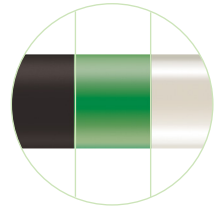







Prime Reverse Cutting 						
Needle	Suture USP	Color	Length	EA/BX	Special	Product Code
 P-6 8mm 1/4 Circle	7-0	Black	1 X 18"/45cm	12		<u>1647G</u>
 P-1 11mm 3/8 Circle	7-0	Black	1 X 18"/45cm	12		<u>1696G</u>
	6-0	Undyed	1 X 18"/45cm	12		<u>689G</u>
	6-0	Black	1 X 18"/45cm	12		<u>697G</u>
	6-0	Black	1 X 18"/45cm	36		<u>697H</u>
	6-0	Green	1 X 18"/45cm	12		<u>G697G</u>
	5-0	Green	1 X 18"/45cm	12		<u>G695G</u>
 P-3 13mm 3/8 Circle	6-0	Black	1 X 18"/45cm	12		<u>1698G</u>
	6-0	Green	1 X 18"/45cm	12		<u>G696G</u>
	5-0	Undyed	1 X 18"/45cm	12		<u>690G</u>
	5-0	Black	1 X 18"/45cm	12		<u>698G</u>
	5-0	Black	1 X 18"/45cm	36		<u>698H</u>
	5-0	Green	1 X 18"/45cm	12		<u>G698G</u>
	4-0	Undyed	1 X 18"/45cm	12		<u>691G</u>
	4-0	Black	1 X 18"/45cm	12		<u>699G</u>
	4-0	Black	1 X 18"/45cm	36		<u>699H</u>
 PS-3 16mm 3/8 Circle	6-0	Black	1 X 18"/45cm	12		<u>1665G</u>
	5-0	Black	1 X 18"/45cm	12		<u>1668G</u>
	5-0	Black	1 X 18"/45cm	36		<u>1668H</u>
 PS-2 19mm 3/8 Circle	5-0	Black	1 X 18"/45cm	12		<u>1666G</u>
	5-0	Black	1 X 18"/45cm	36		<u>1666H</u>
	5-0	Green	1 X 18"/45cm	12		<u>G666G</u>
	4-0	Undyed	1 X 18"/45cm	12		<u>1611G</u>
	4-0	Black	1 X 18"/45cm	12		<u>1667G</u>
	4-0	Black	1 X 18"/45cm	36		<u>1667H</u>
	4-0	Green	1 X 18"/45cm	12		<u>G667G</u>
	3-0	Black	1 X 18"/45cm	36		<u>1669H</u>
	2-0	Black	1 X 18"/45cm	36		<u>593H</u>

General Information	Needle Index	True-to-Scale Needle Diagram	Suturing	Knotless Tissue Control Devices	Sutures: Plus Antibacterial
Sutures: Absorbable	Sutures: Nonabsorbable				

ETHILON® Nylon Suture





Prime Reverse Cutting 						
Needle	Suture USP	Color	Length	EA/BX	Special	Product Code
 PS-1 24mm 3/8 Circle	3-0	Black	1 X 18"/45cm	12	 MultiPass® NEEDLES	1663G
	3-0	Black	1 X 18"/45cm	36	 MultiPass® NEEDLES	1663H
 PS 26mm 3/8 Circle	2-0	Black	1 X 18"/45cm	36	 MultiPass® NEEDLES	585H
 PS-4 16mm 1/2 Circle	6-0	Black	1 X 18"/45cm	12	 MultiPass® NEEDLES	1660G
	5-0	Black	1 X 18"/45cm	12	 MultiPass® NEEDLES	1661G
	4-0	Undyed	1 X 18"/45cm	12	 MultiPass® NEEDLES	1603G
	4-0	Black	1 X 18"/45cm	12	 MultiPass® NEEDLES	1662G



Prime Conventional Cutting 						
Needle	Suture USP	Color	Length	EA/BX	Special	Product Code
 PC-1 13mm 3/8 Circle	6-0	Black	1 X 18"/45cm	12	 MultiPass® NEEDLES	1856G
	6-0	Black	1 X 18"/45cm	12	 MultiPass® NEEDLES	1956G
	5-0	Black	1 X 18"/45cm	12	 MultiPass® NEEDLES	1855G
	5-0	Black	1 X 18"/45cm	12	 MultiPass® NEEDLES	1955G
	4-0	Black	1 X 18"/45cm	12	 MultiPass® NEEDLES	1854G
	4-0	Black	1 X 18"/45cm	12	 MultiPass® NEEDLES	1954G
 PC-3 16mm 3/8 Circle	6-0	Black	1 X 18"/45cm	12	 MultiPass® NEEDLES	1866G
	6-0	Black	1 X 18"/45cm	12	 MultiPass® NEEDLES	1966G
	5-0	Black	1 X 18"/45cm	12	 MultiPass® NEEDLES	1865G
	5-0	Black	1 X 18"/45cm	12	 MultiPass® NEEDLES	1965G
	4-0	Black	1 X 18"/45cm	12	 MultiPass® NEEDLES	1864G
	4-0	Black	1 X 18"/45cm	12	 MultiPass® NEEDLES	1964G

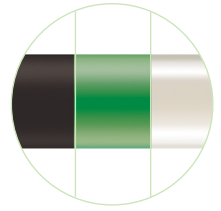

General Information	Needle Index	True-to-Scale Needle Diagram	Suturing	Knotless Tissue Control Devices	Sutures: Plus Antibacterial
Sutures: Absorbable	Sutures: Nonabsorbable				

ETHILON® Nylon Suture



Prime Conventional Cutting 						
Needle	Suture USP	Color	Length	EA/BX	Special	Product Code
 PC-5 19mm 3/8 Circle	5-0	Black	1 X 18"/45cm	12	 MultiPass® NEEDLES	1895G
	5-0	Black	1 X 18"/45cm	12	 MultiPass® NEEDLES	1995G
	4-0	Black	1 X 18"/45cm	12	 MultiPass® NEEDLES	1894G
	4-0	Black	1 X 18"/45cm	12	 MultiPass® NEEDLES	1994G
	3-0	Black	1 X 18"/45cm	12	 MultiPass® NEEDLES	1893G
	3-0	Black	1 X 18"/45cm	12	 MultiPass® NEEDLES	1993G
 PC-12 16mm 1/2 Circle	5-0	Black	1 X 18"/45cm	12		1845G
	5-0	Black	1 X 18"/45cm	12		1945G

Spatula Conventional Cutting 						
Needle	Suture USP	Color	Length	EA/BX	Special	Product Code
 RD-1 8mm 1/4 Circle	5-0	Black	1 X 18"/45cm	12		749G





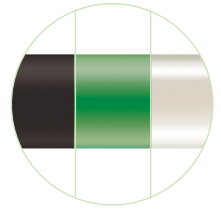

Spatula Reverse Cutting 						
Needle	Suture USP	Color	Length	EA/BX	Special	Product Code
 TG100-8 6.5mm 1/4 Circle	8-0	Black	1 X 12"/30cm	12		1714G
 S-14 8mm 1/4 Circle	5-0	Black	1 X 18"/45cm	12		7731G

General Information	Needle Index	True-to-Scale Needle Diagram	Suturing	Knotless Tissue Control Devices	Sutures: Plus Antibacterial
Sutures: Absorbable	Sutures: Nonabsorbable				

ETHILON® Nylon Suture



Spatula Reverse Cutting

Needle	Suture USP	Color	Length	EA/BX	Special	Product Code
 TG140-6 6.5mm 3/8 Circle	10-0	Black	1 X 12"/30cm	12		<u>7770G</u>
 TG140-8 6.5mm 3/8 Circle	10-0	Black	1 X 12"/30cm	12		<u>7718G</u>
	9-0	Black	1 X 12"/30cm	12		<u>7717G</u>
 TG160-4-3M 4.3mm 1/2 Circle	10-0	Black	1 X 8"/20cm	12		<u>7711G</u>
 TG160-6 5.5mm 1/2 Circle	10-0	Black	1 X 12"/30cm	12		<u>7756G</u>
	10-0	Black	1 X 6"/15cm	12		<u>7757G</u>
	9-0	Black	1 X 12"/30cm	12		<u>7760G</u>
 TG175-8 7mm 1/2 Circle	8-0	Black	1 X 12"/30cm	12		<u>1716G</u>
 S-22 8mm 1/2 Circle	5-0	Black	1 X 18"/45cm	12		<u>1740G</u>









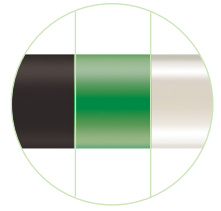

Ultima Reverse Cutting

Needle	Suture USP	Color	Length	EA/BX	Special	Product Code
 CS44-6 6.5mm 1/8 Circle	10-0	Black	1 x 4"/10cm	12		<u>9065G</u>
 CS140-6 6.5mm 3/8 Circle	10-0	Black	1 x 4"/10cm	12		<u>9060G</u>

General Information	Needle Index	True-to-Scale Needle Diagram	Suturing	Knotless Tissue Control Devices	Sutures: Plus Antibacterial
Sutures: Absorbable	Sutures: Nonabsorbable				

ETHILON® Nylon Suture



Ultima Reverse Cutting 						
Needle	Suture USP	Color	Length	EA/BX	Special	Product Code
 CS140-6 6.5mm 3/8 Circle	10-0	Black	1 x 12"/30cm	12		<u>9003G</u>
 CS140-8 6.5mm 3/8 Circle	10-0	Black	1 x 12"/30cm	12		<u>9033G</u>
 CSM-6 4.3mm 1/2 Circle	10-0	Black	1 X 8"/20cm	12		<u>9006G</u>
	10-0	Black	1 x 12"/30cm	12		<u>9005G</u>
 CS160-6 5.5mm 1/2 Circle	10-0	Black	1 x 4"/10cm	12		<u>9061G</u>
 CS160-6 5.5mm 1/2 Circle	11-0	Black	1 X 8"/20cm	12		<u>9016G</u>
	10-0	Black	1 X 6"/15cm	12		<u>9001G</u>
	10-0	Black	1 x 12"/30cm	12		<u>9000G</u>
	9-0	Black	1 x 12"/30cm	12		<u>9011G</u>
 CS160-8 5.5mm 1/2 Circle	10-0	Black	1 X 6"/15cm	12		<u>9031G</u>
	10-0	Black	1 X 12"/30cm	12		<u>9030G</u>
 CS175-6 7mm 1/2 Circle	10-0	Black	1 x 12"/30cm	12		<u>9002G</u>
 CS175-8 7mm 1/2 Circle	10-0	Black	1 X 12"/30cm	12		<u>9032G</u>
	9-0	Black	1 X 12"/30cm	12		<u>9036G</u>
	8-0	Black	1 X 12"/30cm	12		<u>9038G</u>
 CS-C-6 5mm Compound Curve	10-0	Black	1 X 6"/15cm	12		<u>9010G</u>

General Information	Needle Index	True-to-Scale Needle Diagram	Suturing	Knotless Tissue Control Devices	Sutures: Plus Antibacterial
Sutures: Absorbable	Sutures: Nonabsorbable				

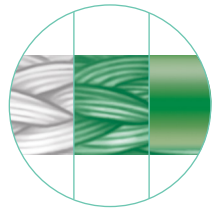

MERSILENE® Polyester Fiber Suture

MERSILENE Suture is a nonabsorbable, braided, sterile surgical suture composed of Poly (ethylene terephthalate). It is prepared from fibers of high molecular weight, long-chain, linear polyesters having recurrent aromatic rings as an integral component.¹

MERSILENE Sutures are indicated for use in general soft tissue approximation and/or ligation, including use in cardiovascular, ophthalmic and neurological procedures.¹





Reference:
1. Ethicon Wound Closure Manual. 2007. Ethicon, Inc.

General Information	Needle Index	True-to-Scale Needle Diagram	Suturing	Knotless Tissue Control Devices	Sutures: Plus Antibacterial
Sutures: Absorbable	Sutures: Nonabsorbable				

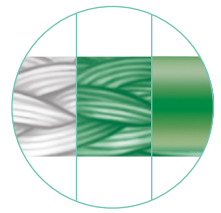
MERSILENE® Polyester Fiber Suture





Taperpoint 						
Needle	Suture USP	Color/Construction	Length	EA/BX	Special	Product Code
 SH 26mm 1/2 Circle	3-0	Green/Braided	1 X 30"/75cm	36		R832H
	2-0	Green/Braided	1 X 30"/75cm	36		R833H
 CT-1 36mm 1/2 Circle	0	Green/Braided	1 X 30"/75cm	36		R424H
	0	Green/Braided	8 X 18"/45cm	24		MR21T



Reverse Cutting 						
Needle	Suture USP	Color/Construction	Length	EA/BX	Special	Product Code
 FS-2 19mm 3/8 Circle	4-0	White/Braided	1 X 18"/45cm	36		R633H
 FS-1 24mm 3/8 Circle	3-0	White/Braided	1 X 18"/45cm	36		R647H
 FS 26mm 3/8 Circle	2-0	White/Braided	1 X 18"/45cm	36		R665H

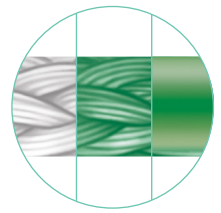

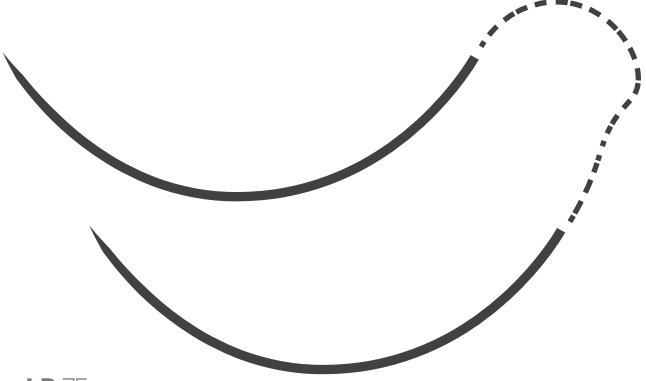
General Information	Needle Index	True-to-Scale Needle Diagram	Suturing	Knotless Tissue Control Devices	Sutures: Plus Antibacterial
Sutures: Absorbable	Sutures: Nonabsorbable				

MERSILENE® Polyester Fiber Suture



Reverse Cutting ▾						
Needle	Suture USP	Color/Construction	Length	EA/BX	Product Code	
 <p>LR 75mm 3/8 Circle</p>	1	Green/Braided	1 X 30"/75cm	24	<u>R495T</u>	
 <p>TG160-4 5.3mm 1/2 Circle</p>	11-0	Green/Monofilament	1 X 12"/30cm	12	<u>R750G</u>	

Prime Reverse Cutting ▾						
Needle	Suture USP	Color/Construction	Length	EA/BX	Special	Product Code
 <p>P-3 13mm 3/8 Circle</p>	5-0	White/Braided	1 X 18"/45cm	12	 MultiPass [®] NEEDLES	<u>R690G</u>
	4-0	White/Braided	1 X 18"/45cm	12	 MultiPass [®] NEEDLES	<u>R691G</u>



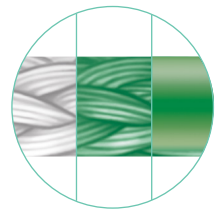

Spatula Conventional Cutting 						
Needle	Suture USP	Color/Construction	Length	EA/BX	Special	Product Code
 <p>RD-1 8mm 1/4 Circle</p>	5-0	Green/Braided	1 X 18"/45cm	12		<u>740G</u>
	5-0	White/Braided	1 X 18"/45cm	12		<u>746G</u>

General Information	Needle Index	True-to-Scale Needle Diagram	Suturing	Knotless Tissue Control Devices	Sutures: Plus Antibacterial
Sutures: Absorbable	Sutures: Nonabsorbable				

MERSILENE® Polyester Fiber Suture



Spatula Reverse Cutting

Needle	Suture USP	Color/Construction	Length	EA/BX	Special	Product Code
 S-14 8mm 1/4 Circle	6-0	White/Braided	1 X 18"/45cm	12		1722G
	5-0	White/Braided	1 X 18"/45cm	12		1760G
	5-0	Green/Braided	1 X 18"/45cm	12		1761G
	5-0	White/Braided	1 X 18"/45cm	12		1764G
 S-24 8mm 1/4 Circle	4-0	Green/Braided	1 X 18"/45cm	12		1762G
 S-4 8mm 1/4 Circle	4-0	White/Braided	1 X 18"/45cm	12		1778G
 TG160-4-3M 4.3mm 1/2 Circle	11-0	Green/Monofilament	1 X 8"/20cm	12		R749G
 S-2 8mm 1/2 Circle	4-0	White/Braided	1 X 18"/45cm	12		1779G

Ultima Reverse Cutting

Needle	Suture USP	Color/Construction	Length	EA/BX	Special	Product Code
 CS140-6 6.5mm 3/8 Circle	10-0	Green/Monofilament	1 x 12"/30cm	12		R770G
 CS160-6 5.5mm 1/2 Circle	10-0	Green/Monofilament	1 x 12"/30cm	12		R756G

General Information	Needle Index	True-to-Scale Needle Diagram	Suturing	Knotless Tissue Control Devices	Sutures: Plus Antibacterial
Sutures: Absorbable	Sutures: Nonabsorbable				

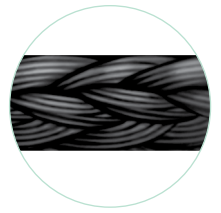

NUROLON® Nylon Suture

NUROLON Suture is a nonabsorbable sterile surgical braided suture composed of the long-chain aliphatic polymer Nylon 6,6. It is dyed black to enhance visibility in tissue. The suture is also available undyed (clear).¹

NUROLON Suture is indicated for use in general soft tissue approximating and/or ligation, including use in cardiovascular, ophthalmic procedures, and neurological procedures.¹









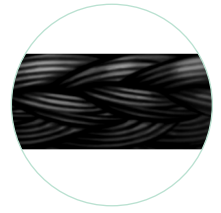















Reference:
1. Ethicon Wound Closure Manual, 2007, Ethicon, Inc.

General Information	Needle Index	True-to-Scale Needle Diagram	Suturing	Knotless Tissue Control Devices	Sutures: Plus Antibacterial
Sutures: Absorbable	Sutures: Nonabsorbable				

NUROLON® Nylon Suture





Taperpoint 						
Needle	Suture USP	Color	Length	EA/BX	Special	Product Code
 TF 13mm 1/2 Circle	4-0	Black	8 X 18"/45cm	12		<u>C584D</u> *
	4-0	Black	8 X 18"/45cm	24		<u>N104T</u>
 RB-1 17mm 1/2 Circle	4-0	Black	8 X 18"/45cm	12		<u>C554D</u> *
	4-0	Black	8 X 18"/45cm	24		<u>N124T</u>
	3-0	Black	8 X 18"/45cm	12		<u>C553D</u> *
 SH-1 22mm 1/2 Circle	3-0	Black	8 X 18"/45cm	12		<u>C503D</u> *
	2-0	Black	8 X 18"/45cm	12		<u>C502D</u> *
 MO-7 22mm 1/2 Circle	2-0	Black	8 X 18"/45cm	12		<u>C542D</u> *
	0	Black	8 X 18"/45cm	12		<u>C541D</u> *
 SH 26mm 1/2 Circle	4-0	Black	8 X 18"/45cm	12		<u>C514D</u> *
	3-0	Black	8 X 18"/45cm	12		<u>C513D</u> *
	2-0	Black	8 X 18"/45cm	12		<u>C512D</u> *
 CT-2 22mm 1/2 Circle	2-0	Black	8 X 18"/45cm	12		<u>C526D</u> *
	0	Black	8 X 18"/45cm	12		<u>C527D</u> *
 MO-6 26mm 1/2 Circle	2-0	Black	8 X 18"/45cm	12		<u>C546D</u> *
	0	Black	8 X 18"/45cm	12		<u>C545D</u> *

General Information	Needle Index	True-to-Scale Needle Diagram	Suturing	Knotless Tissue Control Devices	Sutures: Plus Antibacterial
Sutures: Absorbable	Sutures: Nonabsorbable				

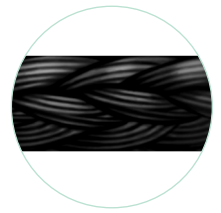
NUROLON® Nylon Suture



Taperpoint 						
Needle	Suture USP	Color	Length	EA/BX	Special	Product Code
 <p>CT-1 36mm 1/2 Circle</p>	2-0	Black	8 X 18"/45cm	12	CR	<u>C522D*</u>
	0	Black	1 X 30"/75cm	36		<u>5424H</u>
	0	Black	8 X 18"/45cm	12	CR	<u>C521D*</u>
	1	Black	1 X 30"/75cm	36		<u>5425H</u>
	1	Black	8 X 18"/45cm	12	CR	<u>C520D*</u>
 <p>CTX 48mm 1/2 Circle</p>	0	Black	8 X 18"/45cm	12	CR	<u>C551D*</u>
	1	Black	8 X 18"/45cm	12	CR	<u>C550D*</u>



Reverse Cutting 						
Needle	Suture USP	Color	Length	EA/BX	Special	Product Code
 <p>FS 26mm 3/8 Circle</p>	4-0	Black	8 X 18"/45cm	12	CR	<u>C570D*</u>
 <p>FSL 30mm 3/8 Circle</p>	3-0	Black	8 X 18"/45cm	12	CR	<u>C566D*</u>
 <p>X-1 22mm 1/2 Circle</p>	3-0	Black	8 X 18"/45cm	12	CR	<u>C563D*</u>

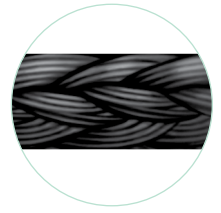

*Safety organizer tray **CR** CONTROL RELEASE Needle Suture

General Information	Needle Index	True-to-Scale Needle Diagram	Suturing	Knotless Tissue Control Devices	Sutures: Plus Antibacterial
Sutures: Absorbable	Sutures: Nonabsorbable				

NUROLON® Nylon Suture



Reverse Cutting ▾						
Needle	Suture USP	Color	Length	EA/BX	Special	Product Code
 CP-2 26mm 1/2 Circle	3-0	Black	8 X 18"/45cm	12	CR	<u>C576D*</u>
	2-0	Black	8 X 18"/45cm	12	CR	<u>C575D*</u>
 CP 40mm 1/2 Circle	2-0	Black	8 X 18"/45cm	12	CR	<u>C572D*</u>
 OS-8 40mm 1/2 Circle	1	Black	3 X 18"/45cm	24	CR	<u>C595T</u>

Prime Conventional Cutting ▲						
Needle	Suture USP	Color	Length	EA/BX	Special	Product Code
 PC-1 13mm 3/8 Circle	6-0	Black	1 X 18"/45cm	12	 MultiPass NEEDLES	<u>5666G</u>
	5-0	Black	1 X 18"/45cm	12	 MultiPass NEEDLES	<u>5665G</u>

*Safety organizer tray **CR** CONTROL RELEASE Needle Suture

General Information	Needle Index	True-to-Scale Needle Diagram	Suturing	Knotless Tissue Control Devices	Sutures: Plus Antibacterial
Sutures: Absorbable	Sutures: Nonabsorbable				

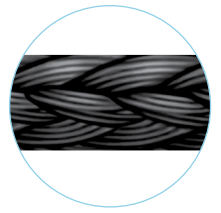

PERMA-HAND® Silk Suture

PERMA-HAND Suture is a nonabsorbable, sterile, surgical suture composed of an organic protein called fibroin. This protein is derived from the domesticated species *Bombyx mori* (B. mori) of the family Bombycidae.¹

The sutures are processed to remove the natural waxes and gums, dyed black and coated with a special wax mixture. PERMA-HAND Suture is also available in its natural color, also available is PERMA-HAND Virgin Silk Suture in which the sericin gum is not removed and serves to hold the filaments together.¹







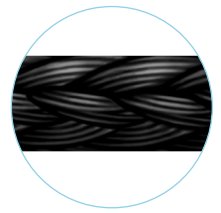

PERMA-HAND Suture is indicated for use in general soft tissue approximating and/or ligation, including use in cardiovascular, ophthalmic, and neurological procedures.¹









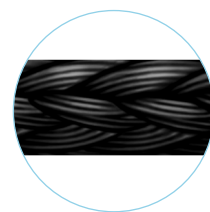

General Information	Needle Index	True-to-Scale Needle Diagram	Suturing	Knotless Tissue Control Devices	Sutures: Plus Antibacterial
Sutures: Absorbable	Sutures: Nonabsorbable				

PERMA-HAND® Silk Suture







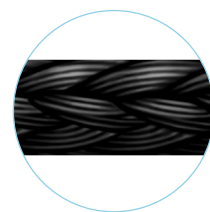

Taperpoint 						
Needle	Suture USP	Color	Length	EA/BX	Special	Product Code
 BV-1 9.3mm 3/8 Circle	6-0	Black	1 X 18"/45cm	36		K802H
 BV-1 9.3mm 3/8 Circle	7-0	Black	1 X 18"/45cm	36		K809H
	7-0	Black	1 X 18"/45cm	36		Q809H
	6-0	Black	1 X 18"/45cm	36		K801H
 C-1 13mm 3/8 Circle	6-0	Black	1 X 18"/45cm	12		707G
	6-0	Black	1 X 30"/75cm	36		K889H
	5-0	Black	1 X 30"/75cm	36		K890H
	4-0	Black	1 x 12"/30cm	12		7734G
	4-0	Black	1 X 30"/75cm	36		K891H
 C-1 13mm 3/8 Circle	6-0	Black	1 X 18"/45cm	12	Siliconized silk	706G
	6-0	Black	1 X 18"/45cm	36		Q706H
	4-0	Black	1 X 18"/45cm	36		709H
 BB 17mm 3/8 Circle	5-0	Black	1 X 30"/75cm	36		K880H
	4-0	Black	1 X 30"/75cm	36		K881H
	3-0	Black	1 X 30"/75cm	36		K882H
	2-0	Black	1 X 30"/75cm	36		K883H
 BB 17mm 3/8 Circle	5-0	Black	1 X 24"/60cm	36		K580H
	4-0	Black	1 X 24"/60cm	36		K581H
 RB-2 13mm 1/2 Circle	4-0	Black	1 X 18"/45cm	36		N267H

PERMA-HAND[®] Silk Suture

Taperpoint 						
Needle	Suture USP	Color	Length	EA/BX	Special	Product Code
 TF 13mm 1/2 Circle	5-0	Black	1 X 18"/45cm	36		<u>N266H</u>
	4-0	Black	8 X 18"/45cm	12	CR	<u>C084D*</u>
	4-0	Black	8 X 18"/45cm	24		<u>M104T</u>
 RB-1 17mm 1/2 Circle	5-0	Black	1 X 30"/75cm	36		<u>K870H</u>
	4-0	Black	8 X 18"/45cm	12	CR	<u>C054D*</u>
	4-0	Black	1 X 30"/75cm	36		<u>K871H</u>
	3-0	Black	8 X 18"/45cm	12	CR	<u>C053D*</u>
	3-0	Black	1 X 30"/75cm	36		<u>K872H</u>
	2-0	Black	1 X 30"/75cm	36		<u>K873H</u>
 RB-1 17mm 1/2 Circle	5-0	Black	1 X 24"/60cm	36		<u>K570H</u>
	4-0	Black	1 X 24"/60cm	36		<u>K571H</u>
	3-0	Black	1 X 24"/60cm	36		<u>K572H</u>
 CT-3 22mm 1/2 Circle	2-0	Black	1 X 20"/50cm	36		<u>413H</u>
 MO-7 22mm 1/2 Circle	0	Black	8 X 18"/45cm	12	CR	<u>C041D*</u>
 SH-1 22mm 1/2 Circle	4-0	Black	8 X 18"/45cm	12	CR	<u>C004D*</u>
	3-0	Black	8 X 18"/45cm	12	CR	<u>C003D*</u>
	3-0	Black	8 X 18"/45cm	24		<u>M3T</u>
 CT-2 26mm 1/2 Circle	2-0	Black	8 X 18"/45cm	12	CR	<u>C026D*</u>
	0	Black	8 X 18"/45cm	12	CR	<u>C027D*</u>

PERMA-HAND® Silk Suture



Taperpoint 						
Needle	Suture USP	Color	Length	EA/BX	Special	Product Code
 MO-6 26mm 1/2 Circle	0	Black	8 X 18"/45cm	12	CR	<u>C045D*</u>
 SH 26mm 1/2 Circle	4-0	Black	5 X 18"/45cm	24	CR	<u>C0145</u>
	4-0	Black	8 X 18"/45cm	12	CR	<u>C014D*</u>
	4-0	Black	1 X 30"/75cm	36		<u>K831H</u>
	4-0	Black	8 X 30"/75cm	12	CR	<u>C018D*</u>
	3-0	Black	5 X 18"/45cm	24	CR	<u>C0135</u>
	3-0	Black	8 X 18"/45cm	12	CR	<u>C013D*</u>
	3-0	Black	8 X 18"/45cm	24		<u>M13T</u>
	3-0	Black	1 X 30"/75cm	36		<u>K832H</u>
	3-0	Black	8 X 30"/75cm	12	CR	<u>C017D*</u>
	2-0	Black	5 X 18"/45cm	24	CR	<u>C0125</u>
	2-0	Black	8 X 18"/45cm	12	CR	<u>C012D*</u>
	2-0	Black	1 X 30"/75cm	36		<u>K833H</u>
	2-0	Black	8 X 30"/75cm	12	CR	<u>C016D*</u>
	0	Black	1 X 30"/75cm	36		<u>K834H</u>
	1	Black	1 X 30"/75cm	36		<u>K835H</u>
 SH 26mm 1/2 Circle	2-0	Black	1 X 24"/60cm	36		<u>K533H</u>
	0	Black	1 X 24"/60cm	36		<u>K534H</u>
 CT-1 36mm 1/2 Circle	2-0	Black	8 X 18"/45cm	12	CR	<u>C022D*</u>
	2-0	Black	1 X 30"/75cm	36		<u>423H</u>
	0	Black	8 X 18"/45cm	12	CR	<u>C021D*</u>
	0	Black	1 X 30"/75cm	36		<u>424H</u>

General Information	Needle Index	True-to-Scale Needle Diagram	Suturing	Knotless Tissue Control Devices	Sutures: Plus Antibacterial
Sutures: Absorbable	Sutures: Nonabsorbable				

PERMA-HAND® Silk Suture

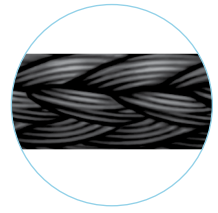









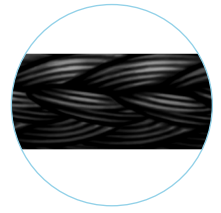

Taperpoint 						
Needle	Suture USP	Color	Length	EA/BX	Special	Product Code
 <p>MH 36mm 1/2 Circle</p>	2-0	Black	8 X 24"/60cm	24		M72T
	2-0	Black	1 X 30"/75cm	36		K843H
	0	Black	1 X 30"/75cm	36		K844H
	1	Black	1 X 30"/75cm	36		K845H
	2	Black	1 X 30"/75cm	36		K846H
 <p>TF-5 8.5mm 5/8 Circle</p>	5-0	Black	1 X 18"/45cm	36		N271H
	4-0	Black	1 X 18"/45cm	36		N272H
 <p>ST-1 45mm Straight</p>	3-0	Black	1 X 30"/75cm	36		K852H

Tapercut Cardio 						
Needle	Suture USP	Color	Length	EA/BX	Special	Product Code
 <p>CC-1 13mm 3/8 Circle</p>	6-0	Black	1 X 12"/30cm	12		7729G
 <p>V-4 17mm 3/8 Circle</p>	4-0	Black	1 X 18"/45cm	12		K945G
 <p>V-5 17mm 1/2 Circle</p>	4-0	Black	1 X 30"/75cm	36		K952H
 <p>V-7 26mm 1/2 Circle</p>	2-0	Black	1 X 30"/75cm	36		K964H

General Information	Needle Index	True-to-Scale Needle Diagram	Suturing	Knotless Tissue Control Devices	Sutures: Plus Antibacterial
Sutures: Absorbable	Sutures: Nonabsorbable				

PERMA-HAND® Silk Suture





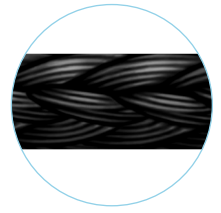

Reverse Cutting 						
Needle	Suture USP	Color	Length	EA/BX	Special	Product Code
 C-2 13mm 3/8 Circle	6-0	Black	1 X 18"/45cm	12		714G
 C-3 13mm 3/8 Circle	4-0	Black	1 X 18"/45cm	12		736G
 C-3 13mm 3/8 Circle	4-0	Black	1 X 12"/30cm	12		735G
 FS-2 19mm 3/8 Circle	5-0	Black	1 X 18"/45cm	12		682G
	4-0	Black	1 X 18"/45cm	12		683G
 FS-1 24mm 3/8 Circle	4-0	Black	1 X 18"/45cm	12		629G
	3-0	Black	1 X 18"/45cm	12		684G
 FS 26mm 3/8 Circle	2-0	Black	1 X 18"/45cm	12		685G
 FSL 30mm 3/8 Circle	3-0	Black	1 X 30"/75cm	36		675H
	2-0	Black	1 X 18"/45cm	12		677G
	2-0	Black	1 X 30"/75cm	36		679H
	0	Black	1 X 18"/45cm	12		678G
	0	Black	1 X 30"/75cm	36		680H
 PSL 30mm 3/8 Circle	2-0	Black	1 X 18"/45cm	36		673H
	2-0	Black	1 X 30"/75cm	36		486H
	0	Black	1 X 18"/45cm	36		580H
	0	Black	1 X 30"/75cm	36		590H
 FSLX 36mm 3/8 Circle	2-0	Black	1 X 30"/75cm	36		1689H

General Information	Needle Index	True-to-Scale Needle Diagram	Suturing	Knotless Tissue Control Devices	Sutures: Plus Antibacterial
Sutures: Absorbable	Sutures: Nonabsorbable				

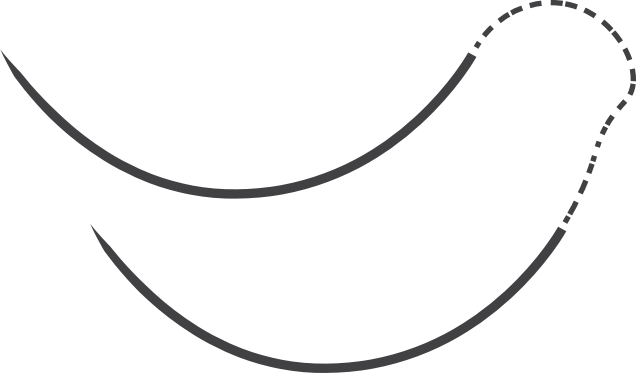
PERMA-HAND® Silk Suture









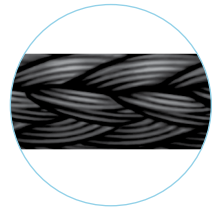













Reverse Cutting ▾						
Needle	Suture USP	Color	Length	EA/BX	Special	Product Code
 PSLX 36mm 3/8 Circle	2-0	Black	1 X 30"/75cm	36		591H
 LR 75mm 3/8 Circle	2	Black	1 X 30"/75cm	24		482T
	5	Black	1 X 30"/75cm	24		485T
 J-1 17mm 1/2 Circle	4-0	Black	1 X 18"/45cm	12		734G
 X-1 22mm 1/2 Circle	3-0	Black	1 X 18"/45cm	12		632G
	2-0	Black	1 X 18"/45cm	12		737G
 CP-1 36mm 1/2 Circle	2-0	Black	1 X 30"/75cm	36		443H
 KS 60mm Straight	4-0	Black	1 X 30"/75cm	36		621H
	3-0	Black	1 X 30"/75cm	36		622H
	3-0	Black	3 X 30"/75cm	36		3622
	2-0	Black	1 X 30"/75cm	36		623H
	0	Black	1 X 30"/75cm	36		624H

General Information	Needle Index	True-to-Scale Needle Diagram	Suturing	Knotless Tissue Control Devices	Sutures: Plus Antibacterial
Sutures: Absorbable	Sutures: Nonabsorbable				

PERMA-HAND® Silk Suture





Prime Reverse Cutting 						
Needle	Suture USP	Color	Length	EA/BX	Special	Product Code
 G-6 8mm 1/4 Circle	7-0	Black	1 X 18"/45cm	12		<u>768G</u>
	6-0	Black	1 X 18"/45cm	12		<u>769G</u>
 G-1 11mm 3/8 Circle	6-0	Black	1 X 18"/45cm	12		<u>786G</u>
 G-1 11mm 3/8 Circle	6-0	Black	1 X 18"/45cm	12		<u>780G</u>
 P-1 11mm 3/8 Circle	6-0	Black	1 X 18"/45cm	12		<u>639G</u>
 G-3 13mm 3/8 Circle	4-0	Black	1 X 18"/45cm	12		<u>789G</u>
 G-3 13mm 3/8 Circle	4-0	Black	1 X 18"/45cm	12		<u>783G</u>
	6-0	Black	1 X 18"/45cm	12		<u>1639G</u>
 P-3 13mm 3/8 Circle	5-0	Black	1 X 18"/45cm	12		<u>640G</u>
	4-0	Black	1 X 18"/45cm	12		<u>641G</u>
	6-0	Black	1 X 18"/45cm	36		<u>1675H</u>
 PS-3 16mm 3/8 Circle	5-0	Black	1 X 18"/45cm	36		<u>1678H</u>
	5-0	Black	1 X 18"/45cm	12		<u>1676G</u>
 PS-2 19mm 3/8 Circle	4-0	Black	1 X 18"/45cm	12		<u>1677G</u>
	3-0	Black	1 X 18"/45cm	36		<u>1679H</u>
	2-0	Black	1 X 18"/45cm	36		<u>583H</u>
	3-0	Black	1 X 18"/45cm	12		<u>1684G</u>

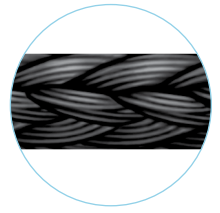

General Information	Needle Index	True-to-Scale Needle Diagram	Suturing	Knotless Tissue Control Devices	Sutures: Plus Antibacterial
Sutures: Absorbable	Sutures: Nonabsorbable				

PERMA-HAND® Silk Suture



Prime Reverse Cutting 						
Needle	Suture USP	Color	Length	EA/BX	Special	Product Code
 PS 26mm 3/8 Circle	2-0	Black	1 X 18"/45cm	36		<u>1588H</u>
 PS-4 16mm 1/2 Circle	4-0	Black	1 X 18"/45cm	12		<u>1687G</u>
 G-7 8mm 1/2 Circle	7-0	Black	1 X 18"/45cm	12		<u>766G</u>
	6-0	Black	1 X 18"/45cm	12		<u>765G</u>

Prime Conventional Cutting 						
Needle	Suture USP	Color	Length	EA/BX	Special	Product Code
 PC-3 16mm 3/8 Circle	5-0	Black	1 X 18"/45cm	12		<u>1925G</u>
 PC-5 19mm 3/8 Circle	4-0	Black	1 X 18"/45cm	12		<u>1984G</u>

Spatula Reverse Cutting 						
Needle	Suture USP	Color	Length	EA/BX	Special	Product Code
 S-14 8mm 1/4 Circle	6-0	Black	1 X 18"/45cm	12		<u>1780G</u>
 TG140-8 6.5mm 3/8 Circle	7-0	Black	1 X 18"/45cm	12		<u>7733G</u>
	6-0	Black	1 X 18"/45cm	12		<u>1732G</u>

General Information	Needle Index	True-to-Scale Needle Diagram	Suturing	Knotless Tissue Control Devices	Sutures: Plus Antibacterial
Sutures: Absorbable	Sutures: Nonabsorbable				

PERMA-HAND® Silk Suture

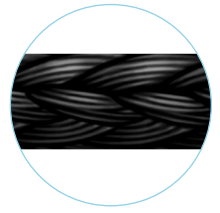

Ligapak Reel

Needle	Suture USP	Color	Length	EA/BX	Special	Product Code
	4-0	Black	1 X 144"/365cm	12		LA53G
	3-0	Black	1 X 144"/365cm	12		LA54G
	2-0	Black	1 X 144"/365cm	12		LA55G

No Needle

Needle	Suture USP	Color	Length	EA/BX	Special	Product Code
	5-0	Black	12 X 18"/45cm	36		A182H
	5-0	Black	12 X 30"/75cm	36		A302H
	4-0	Black	12 X 18"/45cm	36		A183H
	4-0	Black	17 X 18"/45cm	36		SA63H
	4-0	Black	13 X 24"/60cm	36		SA73H
	4-0	Black	10 X 30"/75cm	36		SA83H
	4-0	Black	12 X 30"/75cm	36		A303H
	3-0	Black	12 X 18"/45cm	36		A184H
	3-0	Black	17 X 18"/45cm	36		SA64H
	3-0	Black	13 X 24"/60cm	36		SA74H
	3-0	Black	10 X 30"/75cm	36		SA84H
	3-0	Black	12 X 30"/75cm	36		A304H
	2-0	Black	12 X 18"/45cm	36		A185H
	2-0	Black	17 X 18"/45cm	36		SA65H
	2-0	Black	13 X 24"/60cm	36		SA75H
	2-0	Black	10 X 30"/75cm	36		SA85H
	2-0	Black	12 X 30"/75cm	36		A305H
	2-0	Black	2 X 60"/150cm	36		SA5H
	0	Black	6 X 18"/45cm	36		A186H
	0	Black	17 X 18"/45cm	12		SA66G
	0	Black	13 X 24"/60cm	12		SA76G
	0	Black	6 X 30"/75cm	36		A306H
	0	Black	10 X 30"/75cm	12		SA86G
	0	Black	2 X 60"/150cm	36		SA6H

General Information	Needle Index	True-to-Scale Needle Diagram	Suturing	Knotless Tissue Control Devices	Sutures: Plus Antibacterial
Sutures: Absorbable	Sutures: Nonabsorbable				

PERMA-HAND® Silk Suture

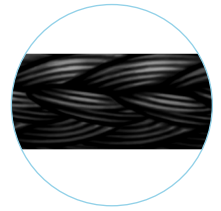

No Needle						
Needle	Suture USP	Color	Length	EA/BX	Special	Product Code
	1	Black	6 X 18"/45cm	36		A187H
	1	Black	13 X 24"/60cm	12		SA77G
	1	Black	6 X 30"/75cm	36		A307H
	1	Black	10 X 30"/75cm	12		SA87G
	1	Black	2 X 60"/150cm	36		SA7H
	2	Black	2 X 60"/150cm	36		SA8H
	3	Black	2 X 60"/150cm	12		SA9G
	4	Black	2 X 60"/150cm	12		SA10G
	5	Black	2 X 60"/150cm	12		SA11G

General Information	Needle Index	True-to-Scale Needle Diagram	Suturing	Knotless Tissue Control Devices	Sutures: Plus Antibacterial
Sutures: Absorbable	Sutures: Nonabsorbable				

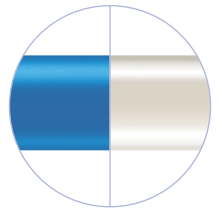

PROLENE® Polypropylene Suture

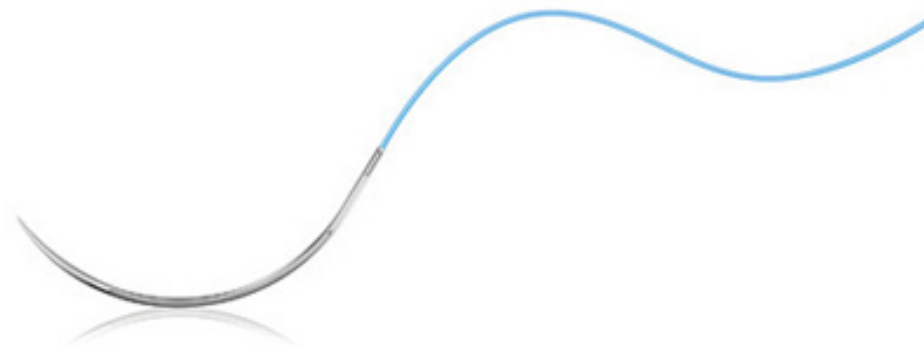

EVERPOINT Needles are a significant advance from stainless steel needles, providing a sharper, stronger, more bend-resistant needle to meet the demands of today's cardiovascular interventions.¹





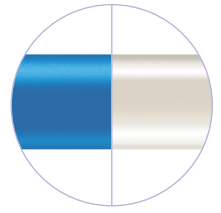













General Information	Needle Index	True-to-Scale Needle Diagram	Suturing	Knotless Tissue Control Devices	Sutures: Plus Antibacterial
Sutures: Absorbable	Sutures: Nonabsorbable				

PROLENE® Polypropylene Suture











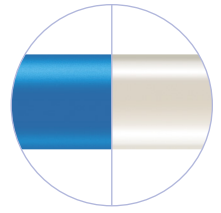



























Blunt Point ETHIGUARD						
Needle	Suture USP	Color	Length	EA/BX	Special	Product Code
 CTB-1 36mm 1/2 Circle	0	Blue	1 X 30"/75cm	36		<u>PB21H</u>
	1	Blue	1 X 30"/75cm	36		<u>PB20H</u>
 CTXB 48mm 1/2 Circle	1	Blue	1 X 30"/75cm	36		<u>PB30H</u>

Taperpoint 						
Needle	Suture USP	Color	Length	EA/BX	Special	Product Code
 BV75-3 3.8mm 3/8 Circle	10-0	Blue	1 X 5"/13cm	12		<u>2790G</u>
 BV100-4 5.1mm 3/8 Circle	10-0	Blue	1 X 5"/13cm	12		<u>2794G</u>
	9-0	Blue	1 X 5"/13cm	12		<u>2793G</u>
 BV100-4 5.1mm 3/8 Circle	10-0	Blue	1 X 2"/5cm	12		<u>2795G</u>
 BV130-5 6.5mm 3/8 Circle	8-0	Blue	1 X 5"/13cm	12		<u>2775G</u>
 BV130-5 6.5mm 3/8 Circle	8-0	Blue	1 X 18"/45cm	36		<u>8730H</u>
	8-0	Blue	1 X 18"/45cm	36	 	<u>EP8730H</u>
	8-0	Blue	2 X 18"/45cm	12		<u>M8738</u>
	8-0	Blue	2 X 18"/45cm	12	 	<u>EPM8738</u>
	8-0	Blue	4 X 18"/45cm	12		<u>M8730</u>
	8-0	Blue	4 X 18"/45cm	12	 	<u>EPM8730</u>

General Information	Needle Index	True-to-Scale Needle Diagram	Suturing	Knotless Tissue Control Devices	Sutures: Plus Antibacterial
Sutures: Absorbable	Sutures: Nonabsorbable				

PROLENE® Polypropylene Suture









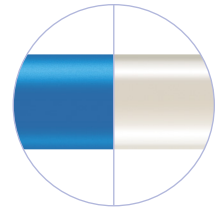

































Taperpoint 						
Needle	Suture USP	Color	Length	EA/BX	Special	Product Code
 BV130-5 6.5mm 3/8 Circle	8-0	Blue	1 X 24"/60cm	36	 MultiPass® NEEDLES	8732H
	8-0	Blue	1 X 24"/60cm	36	 EVP  MultiPass® NEEDLES	EP8732H
	8-0	Blue	2 X 24"/60cm	12	 MultiPass® NEEDLES	M8739
	8-0	Blue	2 X 24"/60cm	12	 EVP  MultiPass® NEEDLES	EPM8739
	8-0	Blue	4 X 24"/60cm	12	 MultiPass® NEEDLES	M8732
	8-0	Blue	4 X 24"/60cm	12	 EVP  MultiPass® NEEDLES	EPM8732
 BV175-6 8mm 3/8 Circle	8-0	Blue	1 X 18"/45cm	36	 MultiPass® NEEDLES	8740H
	8-0	Blue	1 X 18"/45cm	36	 EVP  MultiPass® NEEDLES	EP8740H
	8-0	Blue	2 X 18"/45cm	12	 MultiPass® NEEDLES	M8742
	8-0	Blue	2 X 18"/45cm	12	 EVP  MultiPass® NEEDLES	EPM8742
	8-0	Blue	1 X 24"/60cm	36	 MultiPass® NEEDLES	8741H
	8-0	Blue	1 X 24"/60cm	36	 EVP  MultiPass® NEEDLES	EP8741H
	8-0	Blue	2 X 24"/60cm	12	 MultiPass® NEEDLES	M8743
	8-0	Blue	2 X 24"/60cm	12	 EVP  MultiPass® NEEDLES	EPM8743
	8-0	Blue	4 X 24"/60cm	12	 MultiPass® NEEDLES	M8741
	8-0	Blue	4 X 24"/60cm	12	 EVP  MultiPass® NEEDLES	EPM8741
	7-0	Blue	1 X 18"/45cm	36	 MultiPass® NEEDLES	8734H
	7-0	Blue	1 X 18"/45cm	36	 EVP  MultiPass® NEEDLES	EP8734H
	7-0	Blue	2 X 18"/45cm	12	 MultiPass® NEEDLES	M8736
	7-0	Blue	2 X 18"/45cm	12	 EVP  MultiPass® NEEDLES	EPM8736
	7-0	Blue	4 X 18"/45cm	12	 MultiPass® NEEDLES	M8734
	7-0	Blue	4 X 18"/45cm	12	 EVP  MultiPass® NEEDLES	EPM8734

General Information	Needle Index	True-to-Scale Needle Diagram	Suturing	Knotless Tissue Control Devices	Sutures: Plus Antibacterial
Sutures: Absorbable	Sutures: Nonabsorbable				

PROLENE® Polypropylene Suture





Taperpoint 						
Needle	Suture USP	Color	Length	EA/BX	Special	Product Code
 BV175-6 8mm 3/8 Circle	7-0	Blue	1 X 24"/60cm	36		<u>8735H</u>
	7-0	Blue	1 X 24"/60cm	36	 	<u>EP8735H</u>
	7-0	Blue	2 X 24"/60cm	12		<u>M8737</u>
	7-0	Blue	2 X 24"/60cm	12	 	<u>EPM8737</u>
	7-0	Blue	4 X 24"/60cm	12		<u>M8735</u>
	7-0	Blue	4 X 24"/60cm	12	 	<u>EPM8735</u>
	7-0	Blue	2 X 30"/75cm	12		<u>M8733</u>
	7-0	Blue	2 X 30"/75cm	12	 	<u>EPM8733</u>
	7-0	Blue	4 X 30"/75cm	12		<u>M8731</u>
	7-0	Blue	4 X 30"/75cm	12	 	<u>EPM8731</u>
 BV175-7 8mm 3/8 Circle	8-0	Blue	2 X 24"/60cm	12		<u>M8767</u>
	8-0	Blue	2 X 24"/60cm	12	 	<u>EPM8767</u>
	7-0	Blue	2 X 18"/45cm	12		<u>M8765</u>
	7-0	Blue	2 X 18"/45cm	12	 	<u>EPM8765</u>
	7-0	Blue	4 X 18"/45cm	12		<u>M8764</u>
	7-0	Blue	1 X 24"/60cm	36		<u>8766H</u>
	7-0	Blue	1 X 24"/60cm	36	 	<u>EP8766H</u>
	7-0	Blue	2 X 24"/60cm	12		<u>M8766</u>
	7-0	Blue	2 X 24"/60cm	12	 	<u>EPM8766</u>
	7-0	Blue	4 X 24"/60cm	12		<u>M8775</u>
	7-0	Blue	4 X 24"/60cm	12	 	<u>EPM8775</u>
	7-0	Blue	2 X 30"/75cm	12		<u>M8768</u>
	7-0	Blue	2 X 30"/75cm	12	 	<u>EPM8768</u>
	7-0	Blue	4 X 30"/75cm	12		<u>M8785</u>
	7-0	Blue	4 X 30"/75cm	12	 	<u>EPM8785</u>

General Information	Needle Index	True-to-Scale Needle Diagram	Suturing	Knotless Tissue Control Devices	Sutures: Plus Antibacterial
Sutures: Absorbable	Sutures: Nonabsorbable				

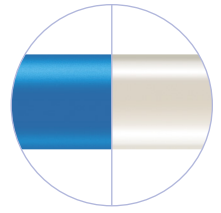
PROLENE® Polypropylene Suture









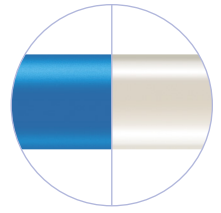































Taperpoint 						
Needle	Suture USP	Color	Length	EA/BX	Special	Product Code
 BV-1 9.3mm 3/8 Circle	7-0	Blue	1 X 18"/45cm	36		8701H
	7-0	Blue	1 X 18"/45cm	36	VB	8301H
	7-0	Blue	4 X 18"/45cm	12		M8701
	7-0	Blue	4 X 18"/45cm	12	VB	M8301
	7-0	Blue	4 X 18"/45cm	12	EVP	EPM8701
	7-0	Blue	1 X 24"/60cm	36		8702H
	7-0	Blue	1 X 24"/60cm	36	VB	8304H
	7-0	Blue	4 X 24"/60cm	12		M8702
	7-0	Blue	4 X 24"/60cm	12	VB	M8304
	7-0	Blue	4 X 24"/60cm	12	EVP	EPM8702
	7-0	Blue	1 X 30"/75cm	36		8703H
	7-0	Blue	2 X 30"/75cm	12		M8203
	7-0	Blue	2 X 30"/75cm	12	EVP	EPM8203
	7-0	Blue	4 X 30"/75cm	12		M8703
	7-0	Blue	4 X 30"/75cm	12	VB	M8303
	7-0	Blue	4 X 30"/75cm	12	EVP	EPM8703
	6-0	Blue	1 X 18"/45cm	36		8806H
	6-0	Blue	1 X 18"/45cm	36	EVP	EP8806H
	6-0	Blue	4 X 18"/45cm	12		M8806
	6-0	Blue	4 X 18"/45cm	12	EVP	EPM8806
	6-0	Blue	1 X 24"/60cm	36		8805H
	6-0	Blue	1 X 24"/60cm	36	EVP	EP8805H
	6-0	Blue	1 X 24"/60cm	36	VB	8305H
	6-0	Blue	2 X 24"/60cm	12		M8205
	6-0	Blue	2 X 24"/60cm	12	EVP	EPM8205
	6-0	Blue	4 X 24"/60cm	12		M8805
	6-0	Blue	4 X 24"/60cm	12	VB	M8305
	6-0	Blue	4 X 24"/60cm	12	EVP	EPM8805
	6-0	Blue	1 X 30"/75cm	36		8709H
	6-0	Blue	1 X 30"/75cm	36	EVP	EP8709H
	6-0	Blue	4 X 30"/75cm	12		M8709
	6-0	Blue	4 X 30"/75cm	12	EVP	EPM8709
	5-0	Blue	1 X 24"/60cm	36		HS 9702H
5-0	Blue	1 X 24"/60cm	36		HS EVP EPH9702H	

General Information	Needle Index	True-to-Scale Needle Diagram	Suturing	Knotless Tissue Control Devices	Sutures: Plus Antibacterial
Sutures: Absorbable	Sutures: Nonabsorbable				

PROLENE® Polypropylene Suture









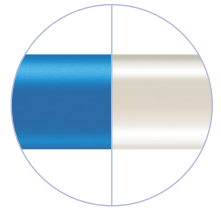













Taperpoint 						
Needle	Suture USP	Color	Length	EA/BX	Special	Product Code
 BV175-8 9.3mm 3/8 Circle	8-0	Blue	1 X 18"/45cm	36		<u>8752H</u>
	8-0	Blue	1 X 18"/45cm	36	 	<u>EP8752H</u>
	8-0	Blue	2 X 18"/45cm	12		<u>M8752</u>
	8-0	Blue	2 X 18"/45cm	12	 	<u>EPM8752</u>
	8-0	Blue	1 X 24"/60cm	36		<u>8753H</u>
	8-0	Blue	1 X 24"/60cm	36	 	<u>EP8753H</u>
	8-0	Blue	2 X 24"/60cm	12		<u>M8753</u>
	8-0	Blue	2 X 24"/60cm	12	 	<u>EPM8753</u>
	8-0	Blue	1 X 30"/75cm	36		<u>8754H</u>
	8-0	Blue	1 X 30"/75cm	36	 	<u>EP8754H</u>
	8-0	Blue	2 X 30"/75cm	12		<u>M8754</u>
	8-0	Blue	2 X 30"/75cm	12	 	<u>EPM8754</u>
	7-0	Blue	1 X 18"/45cm	36		<u>8746H</u>
	7-0	Blue	1 X 18"/45cm	36	 	<u>EP8746H</u>
	7-0	Blue	2 X 18"/45cm	12		<u>M8746</u>
	7-0	Blue	2 X 18"/45cm	12	 	<u>EPM8746</u>
	7-0	Blue	1 X 24"/60cm	36		<u>8747H</u>
	7-0	Blue	1 X 24"/60cm	36	 	<u>EP8747H</u>
	7-0	Blue	2 X 24"/60cm	12		<u>M8747</u>
	7-0	Blue	2 X 24"/60cm	12	 	<u>EPM8747</u>
	7-0	Blue	4 X 24"/60cm	12		<u>M8745</u>
	7-0	Blue	4 X 24"/60cm	12	 	<u>EPM8745</u>
	7-0	Blue	1 X 30"/75cm	36		<u>8755H</u>
	7-0	Blue	1 X 30"/75cm	36	 	<u>EP8755H</u>

General Information	Needle Index	True-to-Scale Needle Diagram	Suturing	Knotless Tissue Control Devices	Sutures: Plus Antibacterial
Sutures: Absorbable	Sutures: Nonabsorbable				

PROLENE® Polypropylene Suture





Taperpoint 						
Needle	Suture USP	Color	Length	EA/BX	Special	Product Code
 BV175-8 9.3mm 3/8 Circle	7-0	Blue	2 X 30"/75cm	12		<u>M8755</u>
	7-0	Blue	2 X 30"/75cm	12	 	<u>EPM8755</u>
	7-0	Blue	4 X 30"/75cm	12	 	<u>EPM8751</u>
 BV 11mm 3/8 Circle	7-0	Blue	4 X 24"/60cm	12		<u>M8600</u>
	6-0	Blue	1 X 24"/60cm	36		<u>8610H</u>
	6-0	Blue	1 X 24"/60cm	36		<u>EP8610H</u>
	6-0	Blue	4 X 24"/60cm	12		<u>M8610</u>
	6-0	Blue	4 X 24"/60cm	12		<u>EPM8610</u>
	6-0	Blue	1 X 30"/75cm	36		<u>8776H</u>
	6-0	Blue	1 X 30"/75cm	36		<u>EP8776H</u>
	6-0	Blue	4 X 30"/75cm	12		<u>M8776</u>
	6-0	Blue	4 X 30"/75cm	12		<u>EPM8776</u>
 C-1 13mm 3/8 Circle	6-0	Blue	1 X 30"/75cm	36		<u>8889H</u>
	6-0	Blue	1 X 30"/75cm	36		<u>EP8889H</u>
	5-0	Blue	1 X 30"/75cm	36		<u>8890H</u>
	5-0	Blue	1 X 30"/75cm	12	 	<u>EPM8890H</u>
 C-1 13mm 3/8 Circle	7-0	Blue	1 X 18"/45cm	36		<u>8800H</u>
	7-0	Blue	1 X 18"/45cm	36		<u>EP8800H</u>
	7-0	Blue	4 X 18"/45cm	12		<u>M8800</u>
	7-0	Blue	4 X 18"/45cm	12		<u>EPM8800</u>
	7-0	Blue	4 X 24"/60cm	12		<u>M8727</u>
	7-0	Blue	4 X 24"/60cm	12		<u>EPM8727</u>
	7-0	Blue	1 X 30"/75cm	36		<u>8708H</u>
	7-0	Blue	1 X 30"/75cm	36		<u>EP8708H</u>

General Information	Needle Index	True-to-Scale Needle Diagram	Suturing	Knotless Tissue Control Devices	Sutures: Plus Antibacterial
Sutures: Absorbable	Sutures: Nonabsorbable				

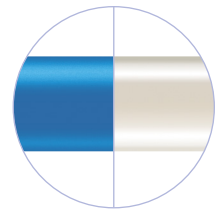
PROLENE® Polypropylene Suture







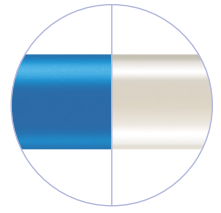

Taperpoint 						
Needle	Suture USP	Color	Length	EA/BX	Special	Product Code
 <p>C-1 13mm 3/8 Circle</p>	6-0	Blue	1 X 18"/45cm	36		<u>8718H</u>
	6-0	Blue	1 X 18"/45cm	36	VB	<u>8318H</u>
	6-0	Blue	1 X 18"/45cm	36	EVP	<u>EP8718H</u>
	6-0	Blue	4 X 18"/45cm	12		<u>M8718</u>
	6-0	Blue	4 X 18"/45cm	12	VB	<u>M8318</u>
	6-0	Blue	4 X 18"/45cm	12	EVP	<u>EPM8718</u>
	6-0	Blue	1 X 24"/60cm	36		<u>8726H</u>
	6-0	Blue	1 X 24"/60cm	36	EVP	<u>EP8726H</u>
	6-0	Blue	4 X 24"/60cm	12		<u>M8726</u>
	6-0	Blue	4 X 24"/60cm	12	EVP	<u>EPM8726</u>
	6-0	Blue	1 X 30"/75cm	36		<u>8706H</u>
	6-0	Blue	1 X 30"/75cm	36	VB	<u>8307H</u>
	6-0	Blue	1 X 30"/75cm	36	EVP	<u>EP8706H</u>
	6-0	Blue	2 X 30"/75cm	12		<u>M8206</u>
	6-0	Blue	2 X 30"/75cm	12	EVP	<u>EPM8206</u>
	6-0	Blue	4 X 30"/75cm	12		<u>M8706</u>
	6-0	Blue	4 X 30"/75cm	12	VB	<u>M8307</u>
	6-0	Blue	4 X 30"/75cm	12	EVP	<u>EPM8706</u>
	5-0	Blue	1 X 18"/45cm	36		<u>8717H</u>
	5-0	Blue	4 X 18"/45cm	12		<u>M8717</u>
	5-0	Blue	1 X 24"/60cm	36		<u>8725H</u>
	5-0	Blue	1 X 24"/60cm	36	VB	<u>8325H</u>
	5-0	Blue	1 X 24"/60cm	36	HS EVP	<u>EPH8725H</u>
	5-0	Blue	4 X 24"/60cm	12		<u>M8725</u>
	5-0	Blue	4 X 24"/60cm	12	VB	<u>M8325</u>
	5-0	Blue	1 X 30"/75cm	36	HS EVP	<u>EPH7477H</u>
	5-0	Blue	1 X 36"/90cm	36		<u>8720H</u>
	5-0	Blue	1 X 36"/90cm	36	VB	<u>8321H</u>
	5-0	Blue	1 X 36"/90cm	36	HS EVP	<u>EPH8720H</u>
	5-0	Blue	2 X 36"/90cm	12		<u>M8220</u>
	5-0	Blue	4 X 36"/90cm	12		<u>M8720</u>
	5-0	Blue	4 X 36"/90cm	12	VB	<u>M8321</u>

General Information	Needle Index	True-to-Scale Needle Diagram	Suturing	Knotless Tissue Control Devices	Sutures: Plus Antibacterial
Sutures: Absorbable	Sutures: Nonabsorbable				

PROLENE® Polypropylene Suture







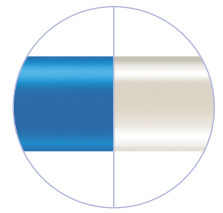

Taperpoint 						
Needle	Suture USP	Color	Length	EA/BX	Special	Product Code
 C-1 13mm 3/8 Circle	4-0	Blue	1 X 30"/75cm	36	HS	<u>9706H</u>
	4-0	Blue	1 X 36"/90cm	36		<u>8519H</u>
 BB 17mm 3/8 Circle	4-0	Blue	1 X 30"/75cm	36		<u>8881H</u>
 BB 17mm 3/8 Circle	5-0	Blue	1 X 24"/60cm	36		<u>8860H</u>
	5-0	Blue	1 X 36"/90cm	36		<u>8580H</u>
	4-0	Blue	1 X 24"/60cm	36		<u>8861H</u>
	4-0	Blue	1 X 36"/90cm	36		<u>8581H</u>
	4-0	Blue	1 X 36"/90cm	36	VB	<u>8381H</u>
	3-0	Blue	1 X 24"/60cm	36		<u>8862H</u>
 RB-3 11mm 1/2 Circle	7-0	Blue	1 X 24"/60cm	36		<u>8206H</u>
 RB-2 13mm 1/2 Circle	6-0	Blue	1 X 18"/45cm	36		<u>8714H</u>
	6-0	Blue	1 X 18"/45cm	36	EVP	<u>EP8714H</u>
	6-0	Blue	1 X 30"/75cm	36		<u>8711H</u>
	6-0	Blue	1 X 30"/75cm	36	EVP	<u>EP8711H</u>
	6-0	Blue	4 X 30"/75cm	12		<u>M8711</u>
	6-0	Blue	4 X 30"/75cm	12	EVP	<u>EPM8711</u>
	5-0	Blue	1 X 18"/45cm	36		<u>8713H</u>
	5-0	Blue	1 X 24"/60cm	36		<u>8554H</u>
	5-0	Blue	1 X 30"/75cm	36		<u>8710H</u>
	5-0	Blue	1 X 30"/75cm	36	HS EVP	<u>EPH8710H</u>
	5-0	Blue	4 X 30"/75cm	12		<u>M8710</u>
	5-0	Blue	1 X 36"/90cm	36	HS EVP	<u>EPH8716H</u>

General Information	Needle Index	True-to-Scale Needle Diagram	Suturing	Knotless Tissue Control Devices	Sutures: Plus Antibacterial
Sutures: Absorbable	Sutures: Nonabsorbable				

PROLENE® Polypropylene Suture







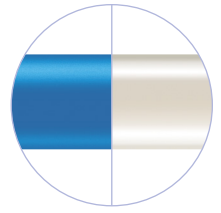

Taperpoint 						
Needle	Suture USP	Color	Length	EA/BX	Special	Product Code
 TF 13mm 1/2 Circle	5-0	Blue	1 X 24"/60cm	36		<u>8205H</u>
	4-0	Blue	1 X 24"/60cm	36		<u>8204H</u>
 RB-1 17mm 1/2 Circle	5-0	Blue	1 X 30"/75cm	36		<u>8870H</u>
	4-0	Blue	1 X 30"/75cm	36		<u>8871H</u>
	3-0	Blue	1 X 30"/75cm	36		<u>8872H</u>
 RB-1 17mm 1/2 Circle	5-0	Blue	1 X 18"/45cm	36		<u>8756H</u>
	5-0	Blue	1 X 24"/60cm	36		<u>8555H</u>
	5-0	Blue	1 X 30"/75cm	36	HS	<u>HS6856H</u>
	5-0	Blue	1 X 36"/90cm	36		<u>8556H</u>
	5-0	Blue	1 X 36"/90cm	36	VB	<u>8356H</u>
	5-0	Blue	1 X 36"/90cm	36	HS	<u>HS8556H</u>
	5-0	Blue	4 X 36"/90cm	12		<u>M8556</u>
	4-0	Blue	1 X 18"/45cm	36		<u>8757H</u>
	4-0	Blue	1 X 36"/90cm	36		<u>8557H</u>
	4-0	Blue	1 X 36"/90cm	36	VB	<u>8357H</u>
	4-0	Blue	1 X 36"/90cm	36	HS	<u>HS6857H</u>
	4-0	Blue	4 X 36"/90cm	12		<u>M8557</u>
	3-0	Blue	1 X 36"/90cm	36		<u>8558H</u>
	3-0	Blue	1 X 36"/90cm	36	HS	<u>9556H</u>
	2-0	Blue	1 X 36"/90cm	36		<u>8559H</u>
 SH-2 20mm 1/2 Circle	4-0	Blue	1 X 36"/90cm	36	HS	<u>HS6861H</u>
 MO-7 22mm 1/2 Circle	0	Blue	8 X 18"/45cm	12	CR	<u>C841G</u>

General Information	Needle Index	True-to-Scale Needle Diagram	Suturing	Knotless Tissue Control Devices	Sutures: Plus Antibacterial
Sutures: Absorbable	Sutures: Nonabsorbable				

PROLENE® Polypropylene Suture







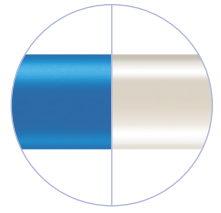

Taperpoint 						
Needle	Suture USP	Color	Length	EA/BX	Special	Product Code
 SH-1 22mm 1/2 Circle	4-0	Blue	1 X 30"/75cm	36		8526H
	3-0	Blue	1 X 30"/75cm	36		8762H
 CT-2 26mm 1/2 Circle	3-0	Blue	1 X 30"/75cm	36		8410H
	2-0	Blue	8 X 18"/45cm	12	CR	C826G
	2-0	Blue	1 X 30"/75cm	36		8411H
	0	Blue	8 X 18"/45cm	12	CR	C827G
	0	Blue	1 X 30"/75cm	36		8412H
 MO-6 26mm 1/2 Circle	2-0	Blue	1 X 30"/75cm	36		8417H
	0	Blue	8 X 18"/45cm	12	CR	C845G
	0	Blue	1 X 30"/75cm	36		8418H
 SH 26mm 1/2 Circle	4-0	Blue	1 X 30"/75cm	36		8831H
	3-0	Blue	1 X 30"/75cm	36		8832H
	2-0	Blue	1 X 30"/75cm	36		8833H
	0	Blue	1 X 30"/75cm	36		8834H
 SH 26mm 1/2 Circle	4-0	Blue	1 X 36"/90cm	36		8521H
	4-0	Blue	1 X 36"/90cm	36	HS	HS6855H
	3-0	Blue	1 X 36"/90cm	36		8522H
	3-0	Blue	1 X 36"/90cm	36	Pledget*	P8522
	3-0	Blue	1 X 36"/90cm	36	HS	HS6822H
	3-0	Blue	1 X 48"/122cm	36		8534H
	2-0	Blue	1 X 36"/90cm	36		8523H
	2-0	Blue	1 X 48"/122cm	36		8533H

General Information	Needle Index	True-to-Scale Needle Diagram	Suturing	Knotless Tissue Control Devices	Sutures: Plus Antibacterial
Sutures: Absorbable	Sutures: Nonabsorbable				

PROLENE® Polypropylene Suture



Taperpoint 						
Needle	Suture USP	Color	Length	EA/BX	Special	Product Code
 <p>CT-1 36mm 1/2 Circle</p>	3-0	Blue	1 X 30"/75cm	36		8422H
	2-0	Blue	8 X 18"/45cm	12	CR	C822G
	2-0	Blue	1 X 30"/75cm	36		8423H
	0	Blue	8 X 18"/45cm	12	CR	C821G
	0	Blue	1 X 30"/75cm	36		8424H
	1	Blue	1 X 30"/75cm	36		8425H
 <p>MH 36mm 1/2 Circle</p>	3-0	Blue	1 X 36"/90cm	36		8842H
	2-0	Blue	1 X 36"/90cm	36		8843H
	2-0	Blue	1 X 48"/122cm	36		8853H
 <p>CT 40mm 1/2 Circle</p>	2-0	Blue	1 X 30"/75cm	36		8433H
	0	Blue	1 X 30"/75cm	36		8434H
	1	Blue	1 X 30"/75cm	36		8435H
 <p>CTX 48mm 1/2 Circle</p>	0	Blue	8 X 18"/45cm	12	CR	C811G
	0	Blue	1 X 30"/75cm	36		8454H
	1	Blue	1 X 30"/75cm	36		8455H
 <p>TP-1 65mm 1/2 Circle</p>	1	Blue	1 X 60"/150cm	12		8824G
	2	Blue	1 X 60"/150cm	12		8825G

PROLENE® Polypropylene Suture

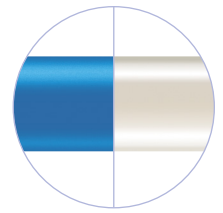

Taperpoint

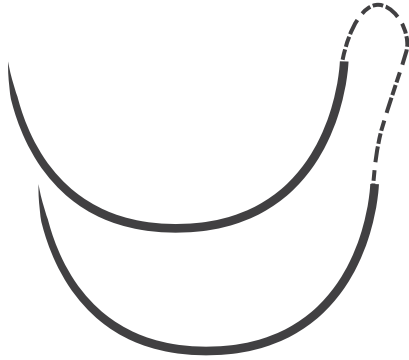
Needle	Suture USP	Color	Length	EA/BX	Special	Product Code
 XLH 70mm 1/2 Circle	0	Blue	3 X 24"/60cm	12		<u>3844G</u>
	1	Blue	1 X 60"/150cm	12		<u>8845G</u>
 XLH 70mm 1/2 Circle	1	Blue	1 X 30"/75cm	12		<u>8190G</u>









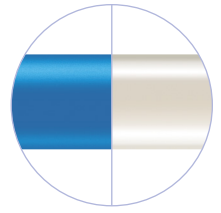



















Tapercut Cardio

Needle	Suture USP	Color	Length	EA/BX	Special	Product Code
 CIF-4 13mm 1/4 Circle	10-0	Blue	1 X 8"/20cm	12		<u>788G</u>
 CC 9.3mm 3/8 Circle	7-0	Blue	1 X 18"/45cm	36		<u>8705H</u>
	7-0	Blue	4 X 18"/45cm	12		<u>M8705</u>
	7-0	Blue	4 X 18"/45cm	12	 	<u>EPM8705</u>

General Information	Needle Index	True-to-Scale Needle Diagram	Suturing	Knotless Tissue Control Devices	Sutures: Plus Antibacterial
Sutures: Absorbable	Sutures: Nonabsorbable				

PROLENE® Polypropylene Suture









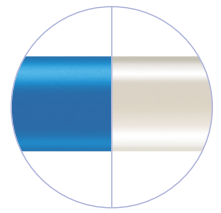

Tapercut Cardio 						
Needle	Suture USP	Color	Length	EA/BX	Special	Product Code
 <p>CC 9.3mm 3/8 Circle</p>	7-0	Blue	1 X 24"/60cm	36	 MultiPass NEEDLES	<u>8704H</u>
	7-0	Blue	4 X 24"/60cm	12	 MultiPass NEEDLES	<u>M8704</u>
	7-0	Blue	4 X 24"/60cm	12	 EVP  MultiPass NEEDLES	<u>EPM8704</u>
	6-0	Blue	1 X 24"/60cm	36	 MultiPass NEEDLES	<u>8807H</u>
	6-0	Blue	1 X 24"/60cm	36	 EVP  MultiPass NEEDLES	<u>EP8807H</u>
	6-0	Blue	4 X 24"/60cm	12	 MultiPass NEEDLES	<u>M8807</u>
	6-0	Blue	4 X 24"/60cm	12	 EVP  MultiPass NEEDLES	<u>EPM8807</u>
 <p>CC-1 13mm 3/8 Circle</p>	6-0	Blue	1 X 18"/45cm	36	 MultiPass NEEDLES	<u>8719H</u>
	6-0	Blue	1 X 18"/45cm	36	 EVP  MultiPass NEEDLES	<u>EP8719H</u>
	6-0	Blue	4 X 18"/45cm	12	 MultiPass NEEDLES	<u>M8719</u>
	6-0	Blue	4 X 18"/45cm	12	 EVP  MultiPass NEEDLES	<u>EPM8719</u>
	6-0	Blue	1 X 30"/75cm	36	 MultiPass NEEDLES	<u>8707H</u>
	6-0	Blue	1 X 30"/75cm	36	 EVP  MultiPass NEEDLES	<u>EP8707H</u>
	6-0	Blue	4 X 30"/75cm	12	 MultiPass NEEDLES	<u>M8707</u>
	6-0	Blue	4 X 30"/75cm	12	 EVP  MultiPass NEEDLES	<u>EPM8707</u>
	5-0	Blue	1 X 36"/90cm	36	 MultiPass NEEDLES	<u>8721H</u>
	5-0	Blue	4 X 36"/90cm	12	 MultiPass NEEDLES	<u>M8721</u>
 <p>V-4 17mm 3/8 Circle</p>	4-0	Blue	1 X 36"/90cm	36		<u>8925H</u>
	3-0	Blue	1 X 36"/90cm	36		<u>8926H</u>

General Information	Needle Index	True-to-Scale Needle Diagram	Suturing	Knotless Tissue Control Devices	Sutures: Plus Antibacterial
Sutures: Absorbable	Sutures: Nonabsorbable				

PROLENE® Polypropylene Suture



Tapercut 						
Needle	Suture USP	Color	Length	EA/BX	Special	Product Code
CC175-8 9.3mm 3/8 Circle	7-0	Blue	4 X 24"/60cm	12		EPM8704SL
	7-0	Blue	4 X 30"/75cm	12		EPM8812SL
 V-5 17mm 1/2 Circle	5-0	Blue	1 X 36"/90cm	36	Pledget*	8934H
	4-0	Blue	1 X 36"/90cm	36		8935H
	4-0	Blue	1 X 36"/90cm	36		P8935
	3-0	Blue	1 X 36"/90cm	36		8936H
	2-0	Blue	1 X 36"/90cm	36		8937H
 V-7 26mm 1/2 Circle	4-0	Blue	1 X 36"/90cm	36		8975H
	3-0	Blue	1 X 36"/90cm	36		8976H
	2-0	Blue	1 X 36"/90cm	36		8977H
	0	Blue	1 X 36"/90cm	36		8978H
 V-34 36mm 1/2 Circle	0	Blue	1 X 30"/75cm	36		8444H
 V-47 36mm Straight	4-0	Blue	1 X 14"/35cm	12		8592G







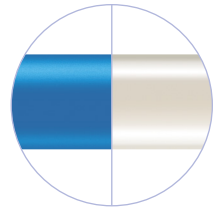

Reverse Cutting 						
Needle	Suture USP	Color	Length	EA/BX	Special	Product Code
 FS-2 19mm 3/8 Circle	5-0	Blue	1 X 18"/45cm	12		8661G
	4-0	Blue	1 X 18"/45cm	12		8683G
	3-0	Blue	1 X 18"/45cm	12		8665G

*7mm x 3mm x 1.5mm Firm TFE Polymer Pledget

General Information	Needle Index	True-to-Scale Needle Diagram	Suturing	Knotless Tissue Control Devices	Sutures: Plus Antibacterial
Sutures: Absorbable	Sutures: Nonabsorbable				

PROLENE® Polypropylene Suture

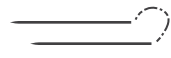







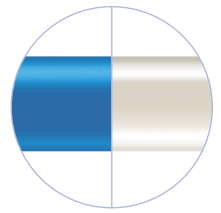



















Reverse Cutting 						
Needle	Suture USP	Color	Length	EA/BX	Special	Product Code
 FS-1 24mm 3/8 Circle	4-0	Blue	1 X 18"/45cm	36		8629H
	3-0	Blue	1 X 18"/45cm	12		8684G
 FS 26mm 3/8 Circle	2-0	Blue	1 X 18"/45cm	36		8685H
 FSL 30mm 3/8 Circle	3-0	Blue	1 X 30"/75cm	36		8675H
 FSLX 36mm 3/8 Circle	3-0	Blue	1 X 30"/75cm	36		8649H
	2-0	Blue	1 X 30"/75cm	36		8689H
	0	Blue	1 X 30"/75cm	36		8690H
 LR 75mm 3/8 Circle	2	Blue	3 X 20"/50cm	24		3846T
 STC-6 16mm Straight	10-0	Blue	1 X 8"/20cm	12		1713G
 TS 48mm Straight	2-0	Blue	1 X 14"/35cm	12		8571G
 KS 60mm Straight	4-0	Blue	1 X 30"/75cm	36		8621H
	3-0	Blue	1 X 30"/75cm	36		8622H
	2-0	Blue	1 X 30"/75cm	36		8623H

General Information	Needle Index	True-to-Scale Needle Diagram	Suturing	Knotless Tissue Control Devices	Sutures: Plus Antibacterial
Sutures: Absorbable	Sutures: Nonabsorbable				

PROLENE® Polypropylene Suture



Prime Reverse Cutting 						
Needle	Suture USP	Color	Length	EA/BX	Special	Product Code
 P-6 8mm 1/4 Circle	7-0	Blue	1 X 18"/45cm	12		<u>8648G</u>
 P-1 11mm 3/8 Circle	7-0	Blue	1 X 18"/45cm	12		<u>8696G</u>
	6-0	Blue	1 X 18"/45cm	12		<u>8606G</u>
	6-0	Blue	1 X 18"/45cm	12		<u>8697G</u>
 P-3 13mm 3/8 Circle	6-0	Blue	1 X 18"/45cm	12		<u>8695G</u>
	5-0	Undyed	1 X 18"/45cm	12		<u>8605G</u>
	5-0	Blue	1 X 18"/45cm	12		<u>8698G</u>
	4-0	Undyed	1 X 18"/45cm	12		<u>8604G</u>
 PS-3 16mm 3/8 Circle	4-0	Blue	1 X 18"/45cm	36		<u>8699G</u>
	6-0	Blue	1 X 18"/45cm	12		<u>8680G</u>
 PS-3 16mm 3/8 Circle	5-0	Blue	1 X 18"/45cm	12		<u>8681G</u>
	5-0	Blue	1 X 18"/45cm	12		<u>8686G</u>
 PS-2 19mm 3/8 Circle	4-0	Blue	1 X 18"/45cm	12		<u>8682G</u>
	4-0	Blue	1 X 18"/45cm	36		<u>8682H</u>
	3-0	Blue	1 X 18"/45cm	36		<u>8687H</u>
	4-0	Blue	1 X 18"/45cm	36		<u>8687H</u>
 PS-1 24mm 3/8 Circle	3-0	Blue	1 X 18"/45cm	12		<u>8663G</u>
 PS-5 13mm 1/2 Circle	5-0	Blue	1 X 18"/45cm	12		<u>8655G</u>
	4-0	Blue	1 X 18"/45cm	12		<u>8656G</u>
 PS-4 16mm 1/2 Circle	4-0	Undyed	1 X 18"/45cm	12		<u>8603G</u>

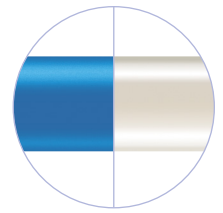

General Information	Needle Index	True-to-Scale Needle Diagram	Suturing	Knotless Tissue Control Devices	Sutures: Plus Antibacterial
Sutures: Absorbable	Sutures: Nonabsorbable				

PROLENE® Polypropylene Suture



Prime Conventional Cutting 						
Needle	Suture USP	Color	Length	EA/BX	Special	Product Code
 PC-1 13mm 3/8 Circle	6-0	Blue	1 X 18"/45cm	12		8617G
	5-0	Blue	1 X 18"/45cm	12		8618G
	4-0	Blue	1 X 18"/45cm	12		8619G
 PC-3 16mm 3/8 Circle	6-0	Blue	1 X 18"/45cm	12		8636G
	5-0	Blue	1 X 18"/45cm	12		8635G
	4-0	Blue	1 X 18"/45cm	12		8634G
 PC-5 19mm 3/8 Circle	5-0	Blue	1 X 18"/45cm	12		8630G
	4-0	Blue	1 X 18"/45cm	12		8631G
	3-0	Blue	1 X 18"/45cm	12		8632G





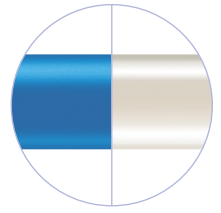

Spatula Reverse Cutting 						
Needle	Suture USP	Color	Length	EA/BX	Special	Product Code
 SM-1 6mm 1/8 Circle	5-0	Blue	1 X 12"/30cm	12		7740G
 TG140-8 6.5mm 3/8 Circle	10-0	Blue	1 X 6"/15cm	12		1757G
	10-0	Blue	1 X 12"/30cm	12		1771G
	9-0	Blue	1 X 6"/15cm	12		1754G

Ultima Reverse Cutting 						
Needle	Suture USP	Color	Length	EA/BX	Special	Product Code
 CTC-6L 13mm 1/4 Circle	10-0	Blue	1 x 4"/10cm	12		9091G

General Information	Needle Index	True-to-Scale Needle Diagram	Suturing	Knotless Tissue Control Devices	Sutures: Plus Antibacterial
Sutures: Absorbable	Sutures: Nonabsorbable				

PROLENE® Polypropylene Suture



Ultima Reverse Cutting 						
Needle	Suture USP	Color	Length	EA/BX	Special	Product Code
 CTC-6, CS160-6 5.5mm 1/4 Circle, 1/2 Circle,	10-0	Blue	1 x 4"/10cm	12		<u>9090G</u>
 CS140-6 6.5mm 3/8 Circle	10-0	Blue	1 X 12"/30cm	12		<u>1710G</u>
 CS160-6 5.5mm 1/2 Circle	10-0	Blue	1 X 12"/30cm	12		<u>7761G</u>
 CS160-8 5.5mm 1/2 Circle	10-0	Blue	1 X 6"/15cm	12		<u>1755G</u>
 CS-C-6 5mm Compound Curve	10-0	Blue	1 X 12"/30cm	12		<u>7796G</u>

General Information	Needle Index	True-to-Scale Needle Diagram	Suturing	Knotless Tissue Control Devices	Sutures: Plus Antibacterial
Sutures: Absorbable	Sutures: Nonabsorbable				

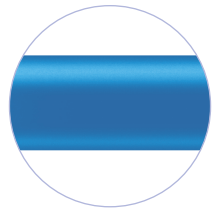





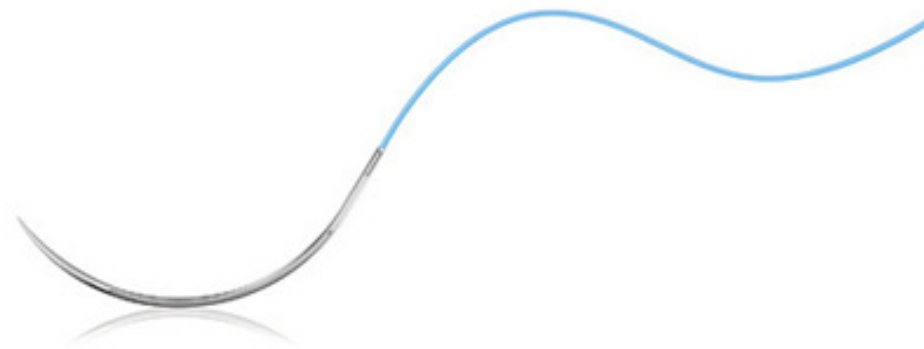

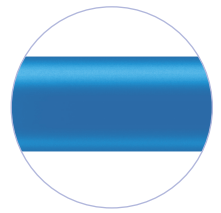

PROLENE[®] Polypropylene Suture HS

EVERPOINT Needles are a significant advance from stainless steel needles, providing a sharper, stronger, more bend-resistant needle to meet the demands of today's cardiovascular interventions.¹



PROLENE® Polypropylene Suture HS



Taperpoint 						
Needle	Suture USP	Color	Length	EA/BX	Special	Product Code
 BV-1 9mm 3/8 Circle	5-0	Blue	1 X 24"/60cm	36	HS	<u>9702H</u>
	5-0	Blue	1 X 24"/60cm	36	HS EVP	<u>EPH9702H</u>
 C-1 13mm 3/8 Circle	5-0	Blue	1 X 30"/75cm	36	HS EVP	<u>EPH8890H</u>
 C-1 13mm 3/8 Circle	5-0	Blue	1 X 24"/60cm	36	HS EVP	<u>EPH8725H</u>
	5-0	Blue	1 X 30"/75cm	36	HS EVP	<u>EPH7477H</u>
	5-0	Blue	1 X 36"/90cm	36	HS EVP	<u>EPH8720H</u>
	4-0	Blue	1 X 30"/75cm	36	HS	<u>9706H</u>
 RB-2 13mm 1/2 Circle	5-0	Blue	1 X 30"/75cm	36	HS EVP	<u>EPH8710H</u>
	5-0	Blue	1 X 36"/90cm	36	HS EVP	<u>EPH8716H</u>
 RB-1 17mm 1/2 Circle	5-0	Blue	1 X 30"/75cm	36	HS	<u>HS6856H</u>
	5-0	Blue	1 X 36"/90cm	36	HS	<u>HS8556H</u>
	4-0	Blue	1 X 36"/90cm	36	HS	<u>HS6857H</u>
	3-0	Blue	1 X 36"/90cm	36	HS	<u>9556H</u>
 SH-2 20mm 1/2 Circle	4-0	Blue	1 X 36"/90cm	36	HS	<u>HS6861H</u>
 SH 26mm 1/2 Circle	4-0	Blue	1 X 36"/90cm	36	HS	<u>HS6855H</u>
	3-0	Blue	1 X 36"/90cm	36	HS	<u>HS6822H</u>

General Information	Needle Index	True-to-Scale Needle Diagram	Suturing	Knotless Tissue Control Devices	Sutures: Plus Antibacterial
Sutures: Absorbable	Sutures: Nonabsorbable				

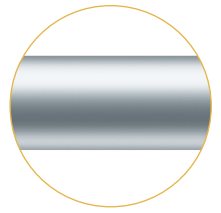

Surgical Stainless Steel Suture

Surgical stainless steel suture is a nonabsorbable, sterile surgical suture composed of 316L stainless steel. The suture is available as a monofilament and multifilament suture.¹

Surgical stainless steel suture is indicated for use in abdominal wound closure, hernia repair, sterna closure and orthopaedic procedures including cerclage and tendon repair.¹







Reference:
1. Ethicon Wound Closure Manual. 2007. Ethicon, Inc.

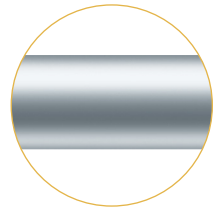

General Information	Needle Index	True-to-Scale Needle Diagram	Suturing	Knotless Tissue Control Devices	Sutures: Plus Antibacterial
Sutures: Absorbable	Sutures: Nonabsorbable				

Surgical Stainless Steel Suture



Taperpoint 						
Needle	Suture USP	Color	Length	EA/BX	Special	Product Code
 <p>CT-1 36mm 1/2 Circle</p>	2-0	Silver	8 X 18"/45cm	12		M682G
 <p>CTX 48mm 1/2 Circle</p>	2-0	Silver	8 X 24"/60cm	12		M414G

Tapercut Cardio 						
Needle	Suture USP	Color	Length	EA/BX	Special	Product Code
 <p>V-40 48mm 1/2 Circle</p>	4	Silver	4 X 18"/45cm	12		M651G
	5	Silver	4 X 18"/45cm	12		M650G
	5	Silver	2 X 18"/45cm	12		M656G
	6	Silver	4 X 18"/45cm	12		M649G
 <p>V-56 60mm 1/2 Circle</p>	5	Silver	4 X 30"/75cm	12		M435G

Tapercut 						
Needle	Suture USP	Color	Length	EA/BX	Special	Product Code
 <p>V-37 40mm 1/2 Circle</p>	1	Silver	4 X 18"/45cm	12		M660G

Surgical Stainless Steel Suture

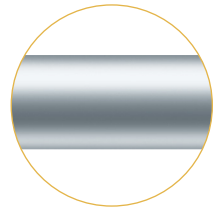

Reverse Cutting ▾						
Needle	Suture USP	Color	Length	EA/BX	Special	Product Code
 FS-2 19mm 3/8 Circle	4-0	Silver	1 X 18"/45cm	12		603G
	3-0	Silver	1 X 18"/45cm	12		607G
 FS-1 24mm 3/8 Circle	3-0	Silver	1 X 18"/45cm	12		631G
 FSLX 45mm 3/8 Circle	2-0	Silver	1 X 18"/45cm	12		618G
 LS-1 45mm 3/8 Circle	2	Silver	4 X 20"/50cm	12		M400G
 LR 75mm 3/8 Circle	2	Silver	1 X 30"/75cm	12		467G
 CP-1 36mm 1/2 Circle	3-0	Silver	1 X 20"/50cm	12		497G
 KS 60mm Straight	5-0	Silver	8 X 16"/40cm	12		M645G

General Information	Needle Index	True-to-Scale Needle Diagram	Suturing	Knotless Tissue Control Devices	Sutures: Plus Antibacterial
Sutures: Absorbable	Sutures: Nonabsorbable				

Surgical Stainless Steel Suture

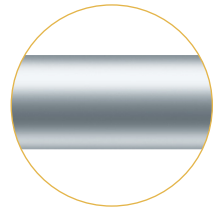

Cutting Edge Conventional 						
Needle	Suture USP	Color	Length	EA/BX	Special	Product Code
 <p>CCS 48mm 1/2 Circle</p>	4	Silver	4 X 18"/45cm	12		M652G
	5	Silver	2 X 18"/45cm	12		M657G
	5	Silver	4 X 18"/45cm	12		M653G
	6	Silver	4 X 18"/45cm	12		M654G
	7	Silver	4 X 18"/45cm	12		M655G
 <p>CCS-1 60mm 1/2 Circle</p>	5	Silver	2 X 30"/75cm	12		M436G

No Needle						
Needle	Suture USP	Color	Length	EA/BX	Special	Product Code
	5-0	Silver	50 X 18"/45cm	12		DS35
	4-0	Silver	50 X 18"/45cm	12		DS32
	3-0	Silver	17 X 18"/45cm	12		SS30G
	3-0	Silver	50 X 18"/45cm	12		DS30
	2-0	Silver	17 X 18"/45cm	12		SS28G
	2-0	Silver	50 X 18"/45cm	12		DS28
	0	Silver	17 X 18"/45cm	12		SS26G
	0	Silver	50 X 18"/45cm	12		DS26
	1	Silver	12 X 18"/45cm	12		DS25
	2	Silver	12 X 18"/45cm	12		DS24
	3	Silver	12 X 18"/45cm	12		DS23
	4	Silver	12 X 18"/45cm	12		DS22
	5	Silver	12 X 18"/45cm	12		DS20
	7	Silver	12 X 18"/45cm	12		DS18

General Information	Needle Index	True-to-Scale Needle Diagram	Suturing	Knotless Tissue Control Devices	Sutures: Plus Antibacterial
Sutures: Absorbable	Sutures: Nonabsorbable				

Other Wound Closure Devices

3-Wide Lazy Susan

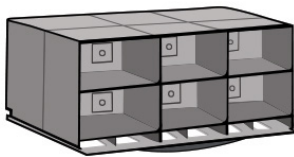

Product Code	Description
--------------	-------------

<u>LS3</u>	15 3/8"L X 11 1/2"W X 20 3/4"H. Includes 6 modular racks. Can be expanded with additional Modular Racks.
------------	----------------------------------------------------------------------------------------------------------

4-Wide Lazy Susan

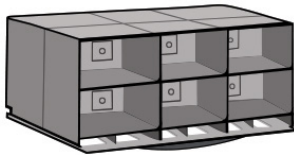

Product Code	Description
--------------	-------------

<u>LS4</u>	20 1/2"L X 11 1/2"W X 20 3/4"H. Includes 8 modular racks. Can be expanded with additional Modular Racks.
------------	----------------------------------------------------------------------------------------------------------

Dispenser Rack

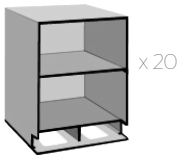

Product Code	Description
--------------	-------------

<u>MR20</u>	25 3/4"L X 5 3/4"W X 27"H. Includes 20 modules, 10 back plates (each with 4 fasteners), 20 module clips, 30 divider panels.
-------------	-----------------------------------------------------------------------------------------------------------------------------

Dispenser Rack

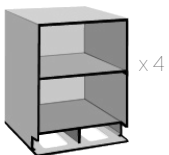

Product Code	Description
--------------	-------------

<u>MR4</u>	10 1/4"L X 5 3/4"W X 13 1/2"H. Includes 4 modules, 3 back plates (each with 4 fasteners), 4 module clips, 8 divider panels.
------------	-----------------------------------------------------------------------------------------------------------------------------

General Information	Needle Index	True-to-Scale Needle Diagram	Suturing	Knotless Tissue Control Devices	Sutures: Plus Antibacterial
Sutures: Absorbable	Sutures: Nonabsorbable				

Other Wound Closure Devices

Portable Carrying Rack

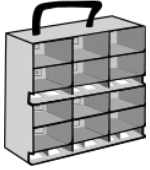

Product Code	Description
<u>PCR1</u>	15 3/8"L x 6 1/8"W x 17 5/8"H. Includes 6 modular racks.

2-Sided Portable Carrying Rack



Product Code	Description
<u>PCR2</u>	15 3/8"L x 12 1/4"W x 16 3/4"H. Includes 12 modular racks.

I.V. Pole with Rack

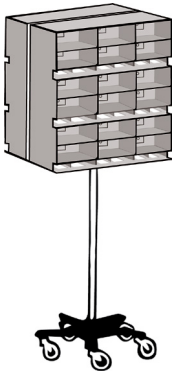

Product Code	Description
<u>SPR1</u>	18 1/4"L x 16 1/2"W x 56 1/2"H. Includes 18 modules racks, 15 module clips, 30 divider panels. Includes 18 modules racks, 15 module clips, 30 divider panels.