

**L187.200**

**USS Grund Instrumente**

**Box01/03**

Pos.	Mat.Nr	Description	Qty	Unit	Location
Box01/03		<b>Tray 01</b>			

1 388.410 Spreizzange für Pedikelschrauben, Länge 330 mm



2 ST B01T01

2 388.440 Haltezange mit breiter Spitze, Länge 290 mm, für Stäbe Ø 6.0 mm



2 ST B01T01

3 1509159 Siebschale für USS Grundinstrumente Basket 1

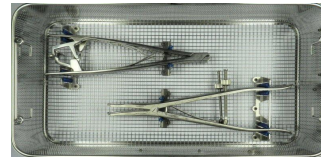

1 ST B01T01

4 ND4825 Deckel für Sieb 480 x 250 mm

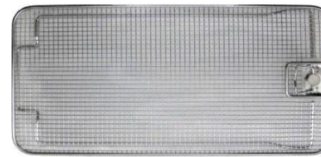

1 ST B01T01

Box01/03 **Tray 02**

5 388.422 Kompressionszange, Länge 335 mm, für Pedikelschrauben



1 ST B01T02

6 388.450 Haltezange für USS-Stäbe Ø 3.5/4.5 mm, Länge 295 mm



1 ST B01T02

Einsatz zu 1509159

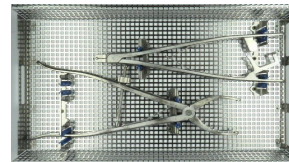











1 ST B01T02

**Box02/03**

Pos.	Mat.Nr	Description	Qty	Unit	Location
Box02/03		<b>Tray 01</b>			

**L187.200**

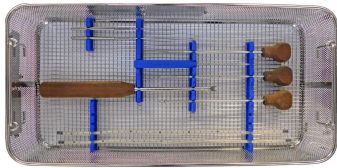
**USS Grund Instrumente**

7	388.538	Pedikelvertiefungsahle Ø 2.8 mm, Länge 230 mm		1	ST	B02T01
8	388.540	Pedikelvertiefungsahle Ø 3.8 mm mit Canevasitgriff, Länge 230 mm, für Pedikelschrauben Ø 5.0 bis 7.0 mm		1	ST	B02T01
9	388.550	Pedikeleröffnungsahle Ø 4.0 mm mit Canevasitgriff, Länge 230 mm, für Pedikelschrauben Ø 4.0 bis 7.0 mm		1	ST	B02T01
10	388.545	Austastinstrument für Schraubenkanal, gerade, Ø 2.3 mm, Länge 275 mm		1	ST	B02T01
11	388.546	Austastinstrument für Schraubenkanal, gebogen, Ø 2.3 mm, Länge 275 mm		1	ST	B02T01
12	388.880	Probestab Ø 6.0 mm, Länge 400 mm		2	ST	B02T01
13	388.940	Stößel für USS-Stäbe Ø 6.0 mm		1	ST	B02T01
14	314.070	6kt-SchrZieh kl 2.5 m/Nut		1	ST	B02T01
15	1509160	Siebschale für USS Grundinstrumente Basket 2		1	ST	B02T01
16	ND4825	Deckel für Sieb 480 x 250 mm		1	ST	B02T01

**Box02/03**

Pos.	Mat.Nr	Description	Qty	Unit	Location
Box02/03		<b>Tray 02</b>			
17	388.406	Distraktor, schwenkbar, mit kurzen Füßchen, Länge 320 mm, für Pedikelschrauben Click'X Standard	1	ST	B02T02





Depuy Synthes GmbH Im Brunnenfeld 8  
OrthoKit® Rental Service D-79224 Umkirch

www.depuySynthes.com



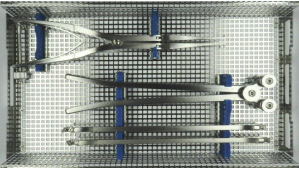

**L187.200**

**USS Grund Instrumente**

18	388.910	USS-Biegeeisen, links		1	ST	B02T02
19	388.920	USS-Biegeeisen, rechts		1	ST	B02T02
20	388.960	Biegezange mit Rollen für USS-Stäbe Ø 6.0 mm, Länge 300 mm		1	ST	B02T02
		Einsatz zu 1509160		1	ST	B02T02

**Box03/03**

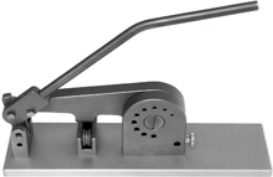
Pos.	Mat.Nr	Description	Qty	Unit	Location
Box03/03		<b>Tray 01</b>			

21	388.750	USS-Stabschneide- und Biegeinstrument		1	ST	B03T01
		Bestehend aus:				
		50134905 Betätigungshebel m/Griff				
						
						

## L187.200

## USS Grund Instrumente

B01T01

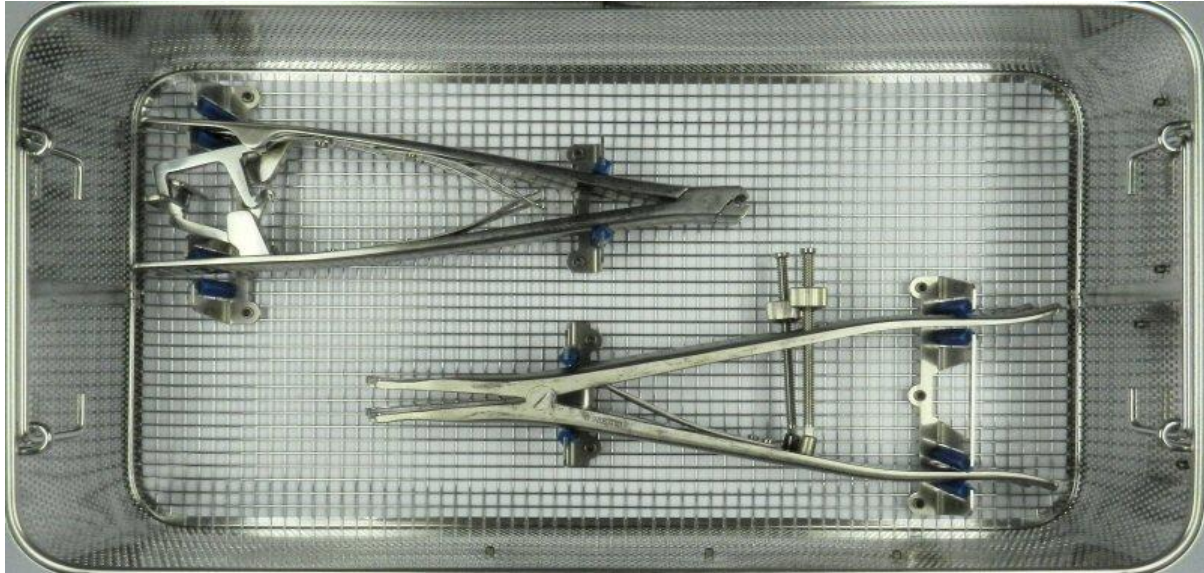

B01T02

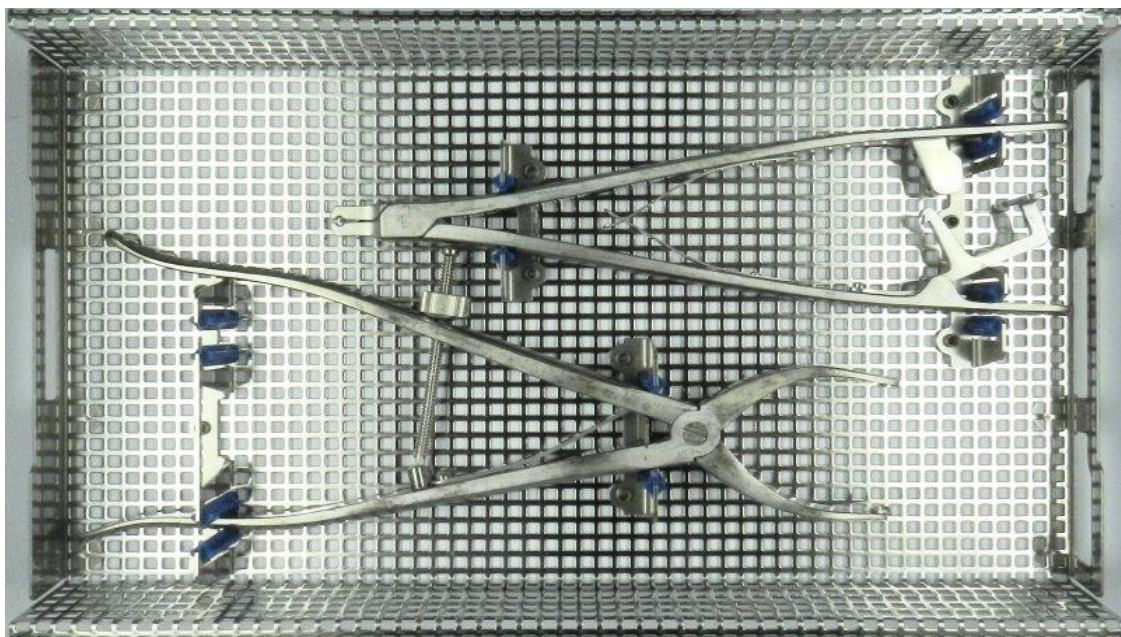

## L187.200

## USS Grund Instrumente

B02T01

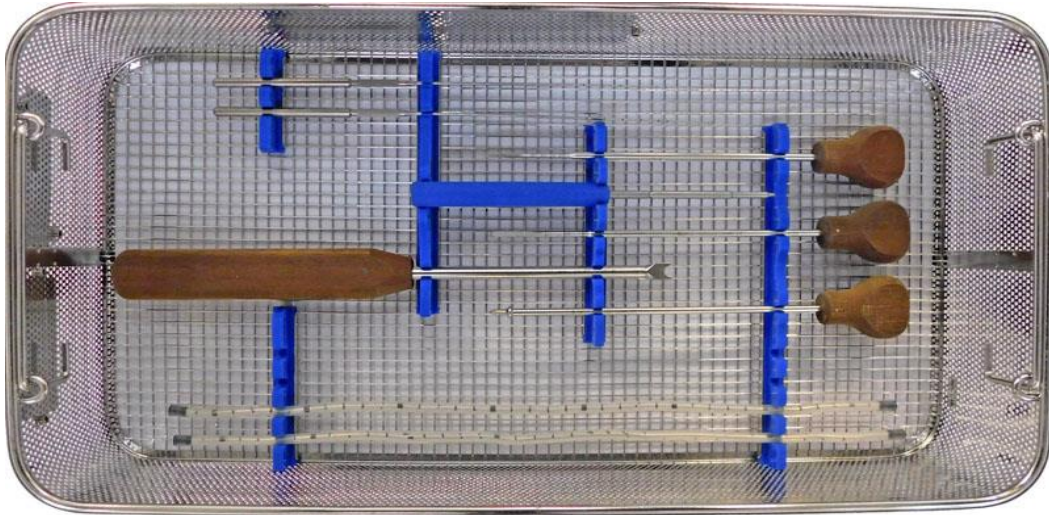

B02T02

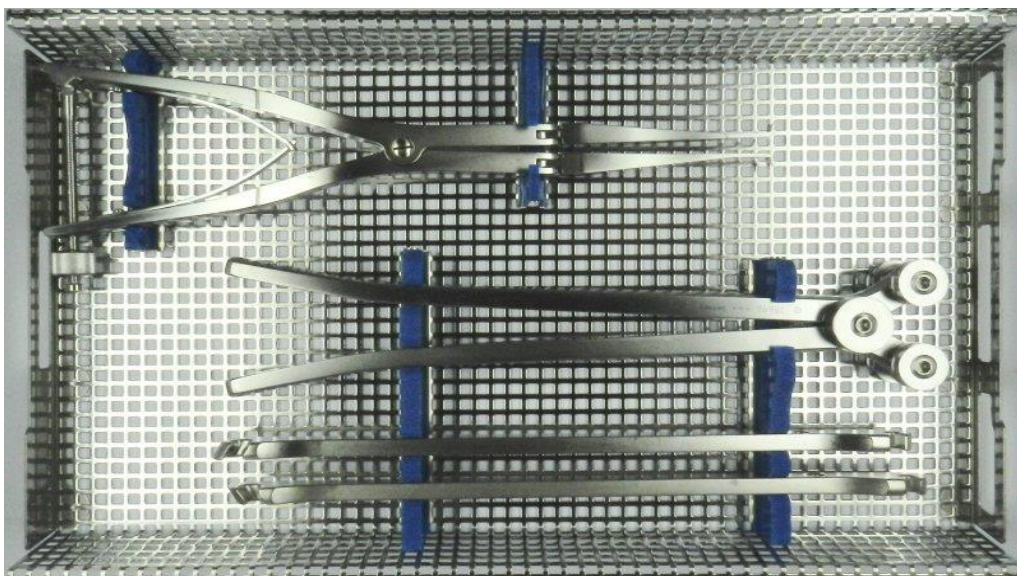

---

**L187.200**

**USS Grund Instrumente**

**B03T01**

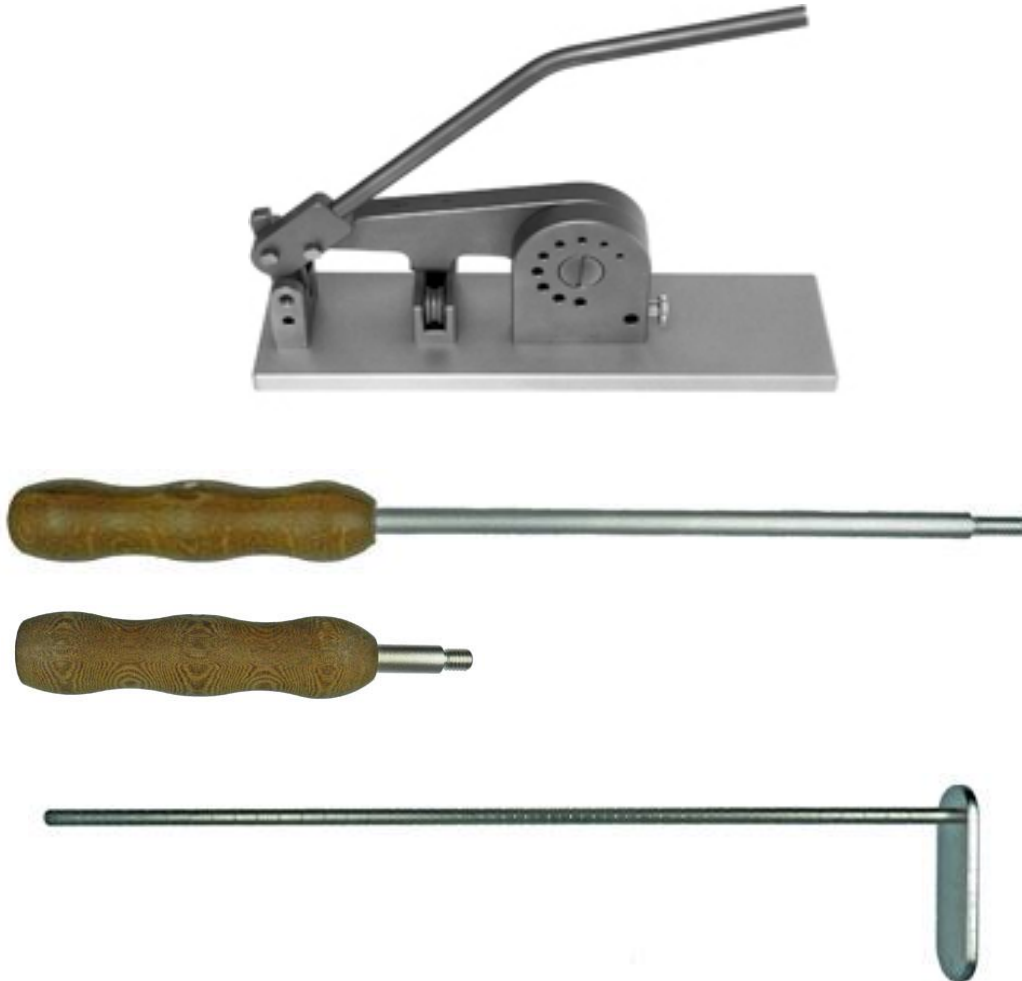

\*\*\*End of document\*\*\*

<b>Document Revision History</b>			
<b>Version Number</b>	<b>Section</b>	<b>Description of Change</b>	<b>Justification of Change</b>
1.0	All	New document	
2.0	All	Umrüstung in NTOC	Set Upgrade
3.0	All	Setname angepasst	Set Update
4.0	All	Bilder aktualisiert	Set Update
5.0	B02T01	1x 388.860 abgerüstet	Set Reduction
6.0	B02T01	1x 314.070 aufgerüstet + Traybild aktualisiert	Set Upgrade

Document Approvals  
Approved Date: 13 Nov 2024

Additional Approval Task Verdict: Approve	Daniel Fischer, (dfische2@its.jnj.com) Department Approval 13-Nov-2024 15:08:59 GMT+0000
--	---

Additional Approval Task Verdict: Approve	Harald Brink, (hbrink1@its.jnj.com) Quality Approval 13-Nov-2024 16:09:37 GMT+0000
--	---